

# NEXPAND

TECHNICAL DATA SHEET  
SERVER CABINET

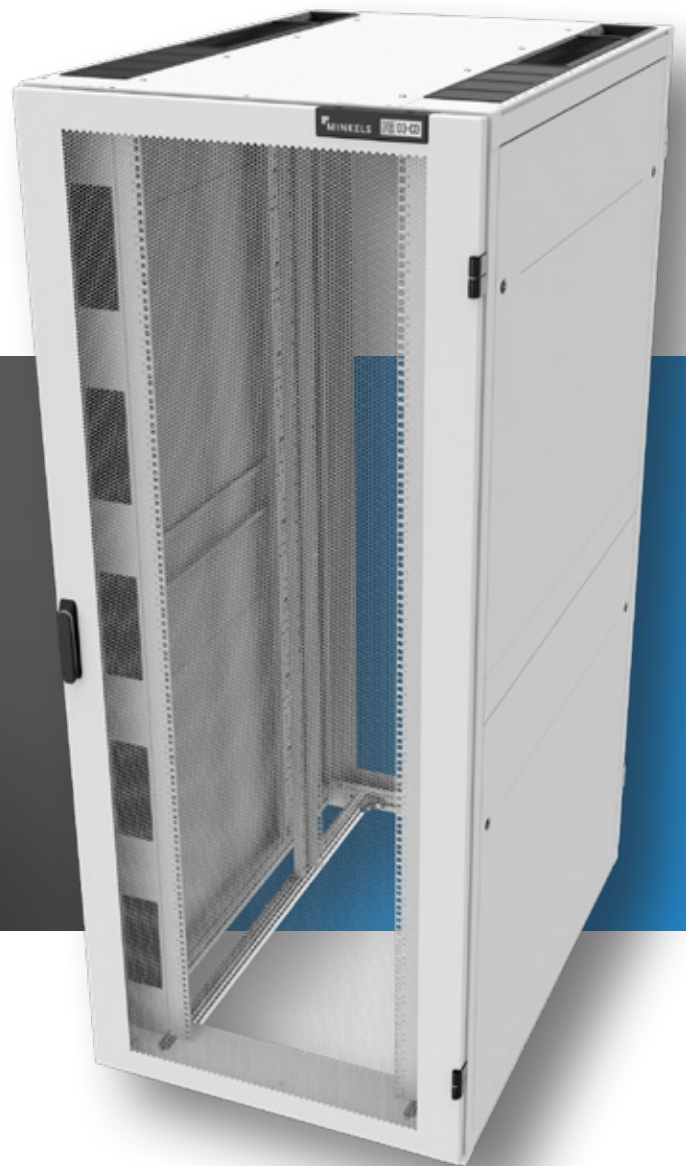
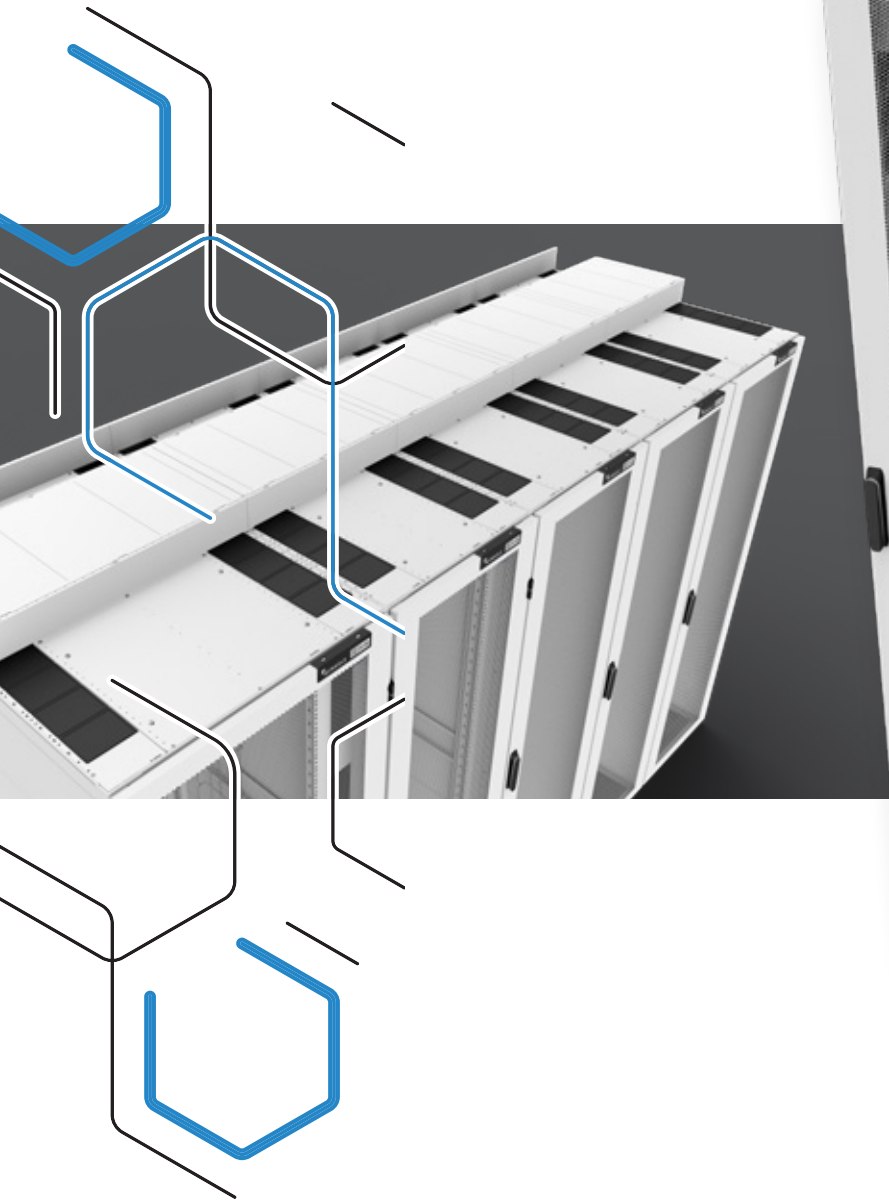

# NEXPAND

## SERVER CABINETS

The **Nexpand server cabinets** are perfectly suited for the installation of (blade) servers, switches, patch panels, routers and storage equipment. The cabinets are used to bring together IT equipment and the corresponding cables neatly in one place. The server cabinets have everything to facilitate this in the best energy efficient and modular way. The cabinets are widely applicable and modular in structure. What type of cabinet is most suitable depends highly on its application. The server cabinets can be configured in varying heights, widths and depths.

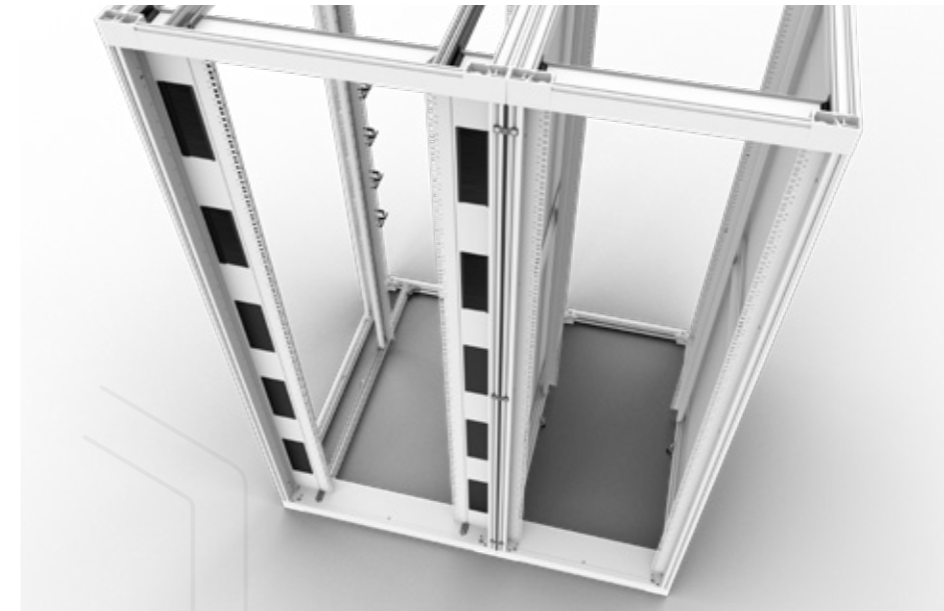
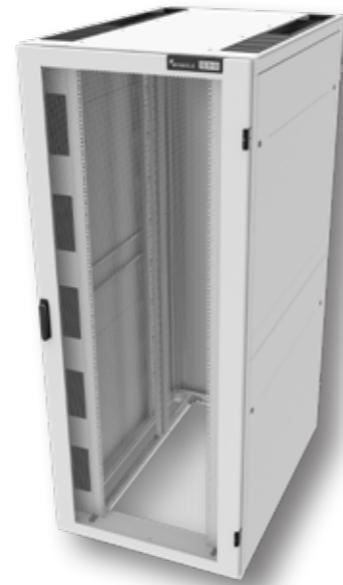

SPECIFICATIONS		
<b>Dimensions:</b>		
Height	U	42, 47 or 52
Height	mm	1978, 2200 or 2422 mm
Width	mm	600 or 800
Depth	mm	1000 or 1200
<b>General:</b>		
Colour		RAL 9003 (white) / RAL 9005 (black)
Static load capacity	kg	1500
Earthing		Fully earthed with central earthing point
IP grade		IP20
Standards compliancy		IEC-60297-3-109; IEC-60297-3-100
		IEC-61587-1;
		Environmental: C1, A1; Static load LT1, ST1, NL5;
<b>Interior:</b>		
19-inch profiles	pcs	4 • steel, powder coated
Adjustability (depth)		Stepless adjustability with depth marking
Adjustability (width)		Stepless adjustability
U marking		1st U at bottom
Position, front profiles		Pre-mounted 80 mm from the front of the door
Position, rear profiles		Pre-mounted at 740mm pitch
<b>Frame:</b>		
Material		Aluminium extrusions
Finishing		Powder coated
<b>Front/rear closure:</b>		
Front door		80% perforated <u>single</u> front door
Rear door		80% perforated <u>single</u> rear door OR 80% perforated <u>double</u> rear door
Security		2-Points Fix-Easy swivel handle with an EK-333 cylinder lock / blind stop
Material		Steel
Finishing		Powder coated
Hinges		Easily reversible and fast placement • Max. rotation degree 260°
<b>Left/right closure:</b>		
Material		Steel
Finishing		Powder coated
<b>Roof:</b>		
Modularity		Modular inserts per 100 mm
Inserts:		Cover panels, cable entry guides and brushes
Cover panels		Possibility to 'break' 1x 200 mm to 2x 100 mm • Material: ABS • Flammability: UL 94 V-0
Cable entry guides		Material: ABS • Flammability: UL 94 V-0

The **Nexpand server cabinets** are available in various types. **A standard version, a version with side panels, airflow package and /or cable tray.**

### SIDE PANEL

A side panel is especially used for end-of-row applications to aesthetically cover the side of the cabinet. The panel is horizontally divided for easy handling. Side panels are equipped with quarter turn locks.

### AIRFLOW MANAGEMENT

Airflow management is the efficient guidance of the various airflows in data centers to keep the cold and hot air separated optimally. To optimize that cooling process, air leakage and recirculation must be minimized by using an airflow management package. Airflow management packages consist of a plate on the bottom, top, left and right. The airflow management package enables an air tight adjustability in the depth direction of 150 mm.

### CABLE TRAY

Structured cabling is important for the reliability and optimum performance of your data center. The cable tray is used for vertical cable management and is steplessly adjustable in depth direction. Cables can be attached to the tray using tie-wraps and/or Velcro. Additionally plastic 1U cable rings can be toolless mount to the cable tray.

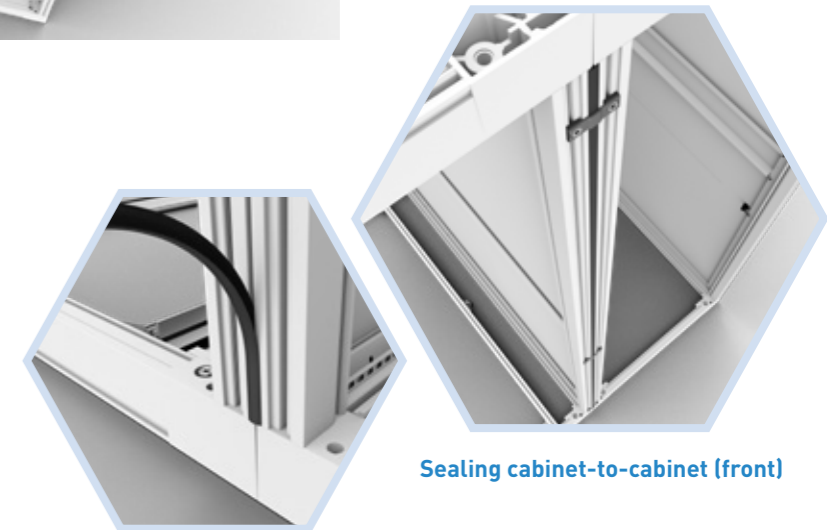

Sealing cabinet-to-cabinet (front)





# NEXPAND

## SERVER CABINETS General features

### FRAME

- Light and solid aluminium frame with the capability to handle 1500 kg of static load.
- Offers unique flexibility through stepless mounting possibilities in all three dimensions of the cabinet.
- Threaded mounting rails in width, depth and height direction enable stepless adjustability (for example cable management).
- Integrated T-slots provide stepless adjustability in depth and width direction (for example vertical mounting rail adjustment).
- Nearly all accessories and components accessible from inside of the cabinet.
- The cabinet is ready for placement of slide-in-side panels. This feature provides separation of cabinets, even after the cabinets are already installed and bayed.
- Upgrade the energy efficiency by adding an airflow package in a later stage is possible.

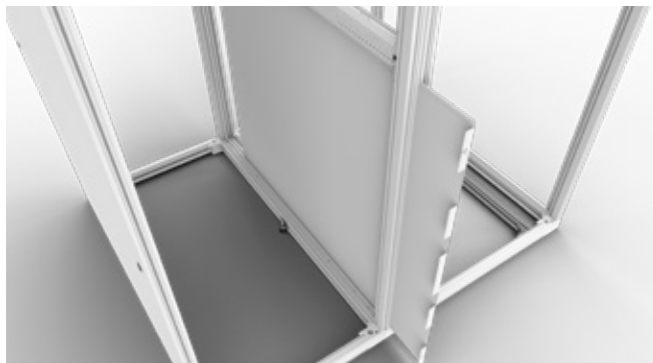

Slide-in side panel ready (rear)



Depth marking placed on depth profiles  
Stepless adjustability in depth direction

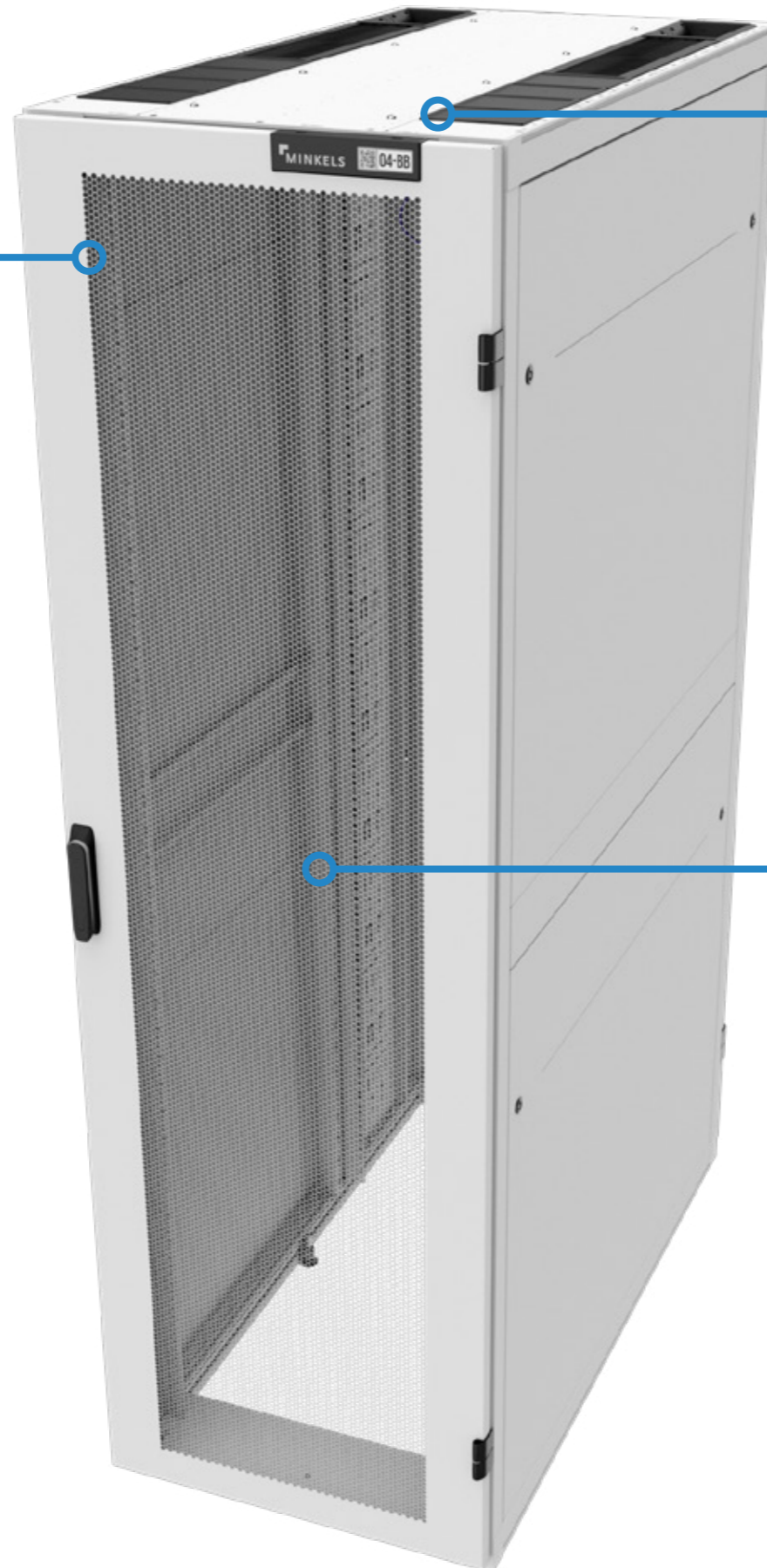

### ROOF

- Solid platform for installation top of cabinet infrastructure.
- Roof inserts follow a multiple of 100 mm.
- Nearly full-depth cut-out.
- Optimal accessibility for cabling.
- Optimal positioning for PDU's.
  - Up to 32A plugs shall fit.
- Cable pull relief available.
- Cable dividers on top of cabinet follow the same modularity as the inserts.
  - Extendable per cabinet to create a cable duct system.
  - Cover plates and end covers available for dust/debris protection and airtight solutions.
  - Powder coated in same color as cabinet.
- Roof is compliant with hot/cold aisle containment.

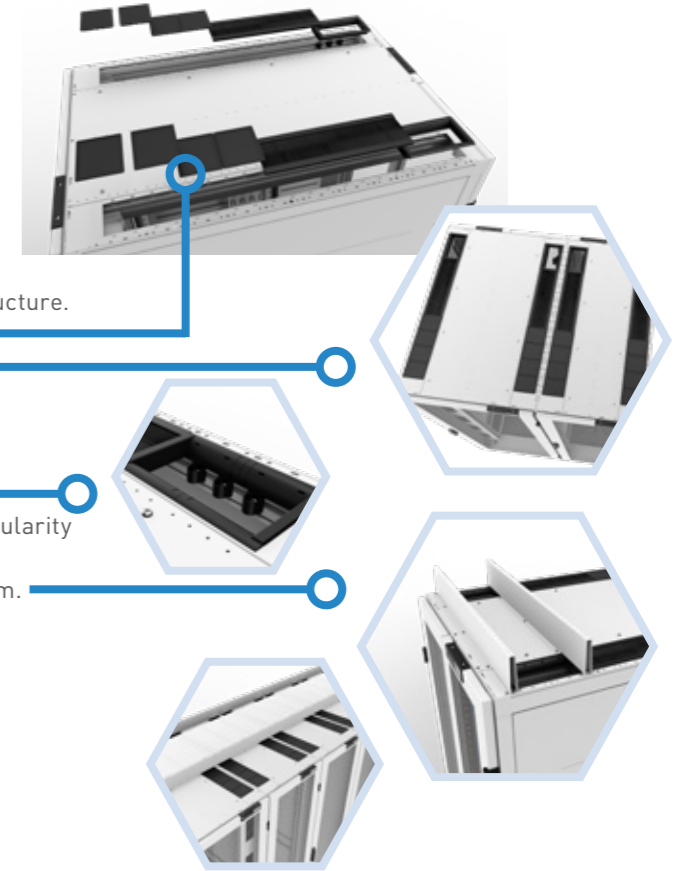

### DOOR

- Predefined position for identification.
  - Place serial numbers, barcodes or QR codes to code and personalize your cabinets.
- Clean and minimalistic design.
- Easy door installation.
- High level perforation.
- Full integration of the locking mechanism and cabling (in case of smart lock).
- High level access security.
- Support of different types of locking possible.
- Replacement of locking through detachable cover plate rear.
- Door easily reversible (left/right hinged).
- Door can open 165° in case of bayed cabinets.
- Door can open 260° in case of stand-alone cabinets.

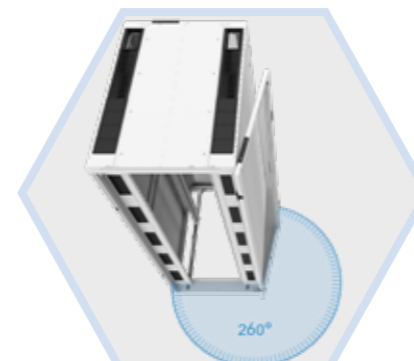

# NEXPAND

## SERVER CABINETS

### Unique features

#### SERVER CABINETS WITH AIRFLOW MANAGEMENT PACKAGE

- Best in class air tightness
- Keep flexibility in adjusting vertical mounting rails without compromising on air tightness.
- Upgrade the energy efficiency by retrofitting an airflow package
- Sealing cabinet-to-cabinet is optional
- Sealing cabinet-to-floor and cabinet-to-aisle containment is optional

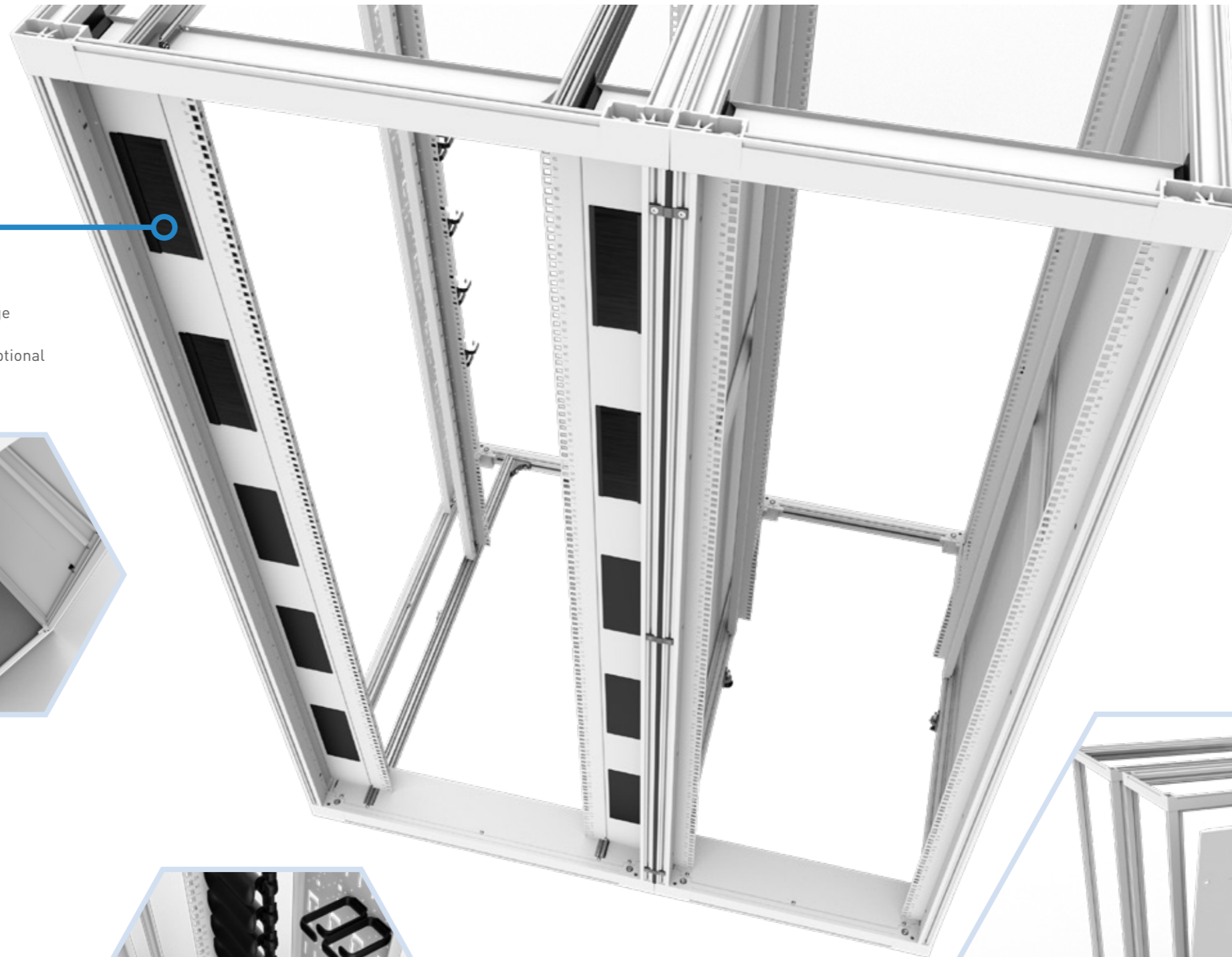
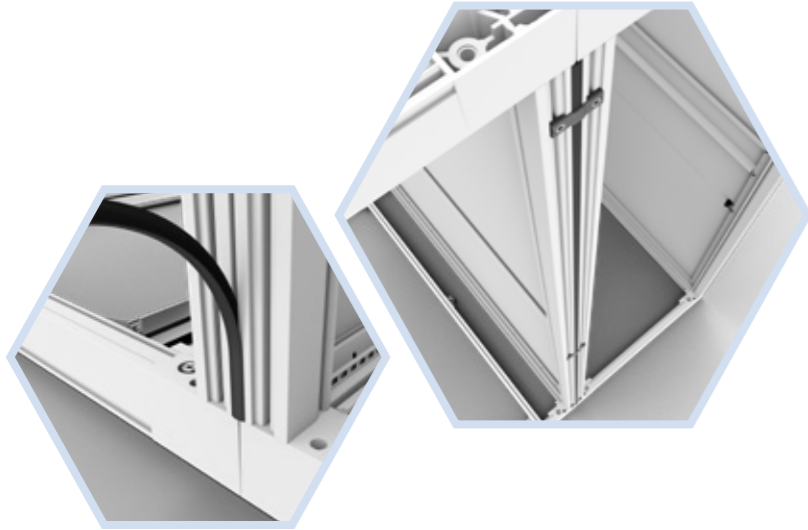

#### SERVER CABINETS WITH CABLE TRAY

- Stepless adjustability in depth direction
- Multifunctional cable tray to organise your cabling
  - using tie-wraps and/or Velcro
  - 1U plastic cable ring, toolless mount



#### SERVER CABINETS WITH SIDE PANEL

- Side panels are used when stand-alone is preferred or when the cabinet is placed at the end of the row
- Earthing connection is established when locking the panels
- Horizontally divided panels for easy handling





# NEXPAND

## STANDARD SERVER CABINET 600 MM WIDE

Position vertical mounting rail



A-A

Top view

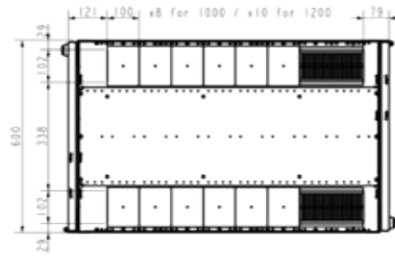

Top view

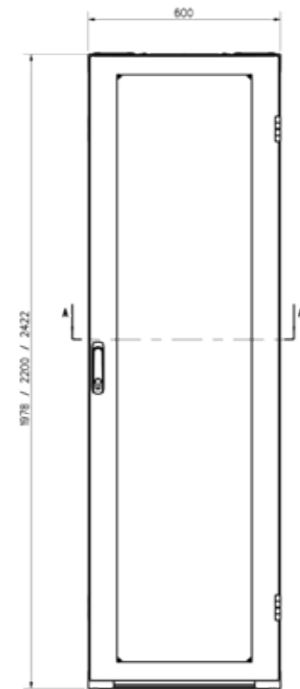
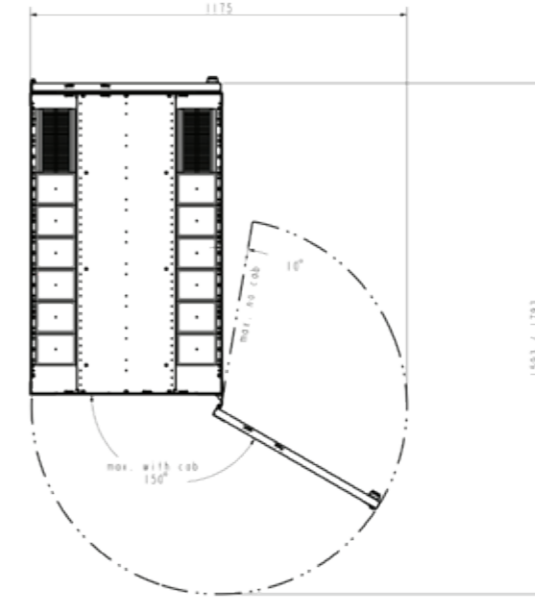
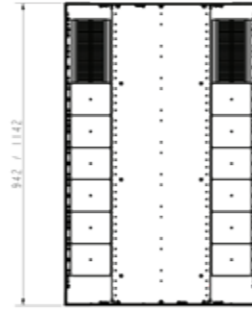

Total height

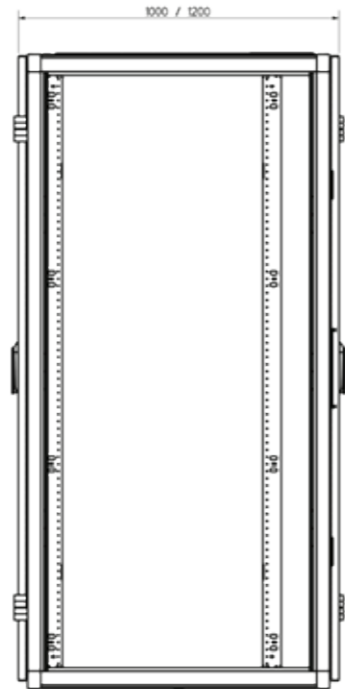

Side view with door



Front view

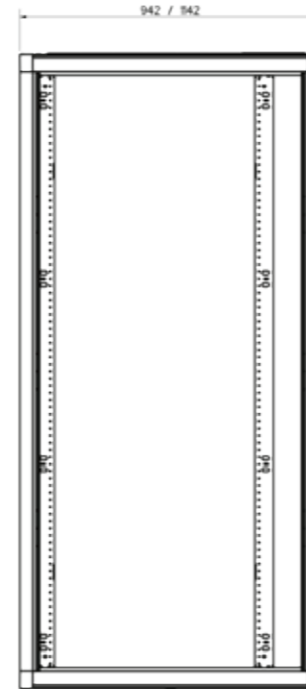

Side view without door

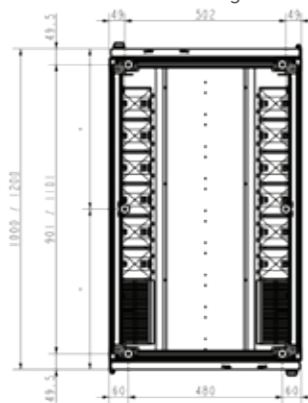

Bottom view

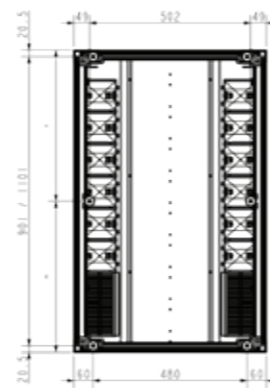

Bottom view

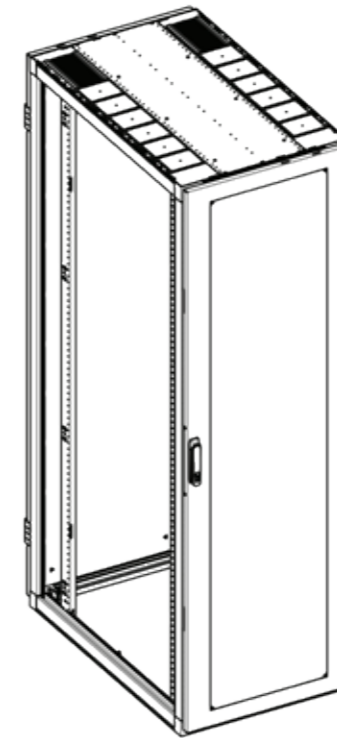

# NEXPAND

## STANDARD SERVER CABINET 800 MM WIDE

Position vertical mounting rail

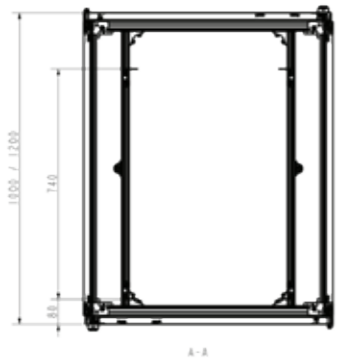

A-A

Top view

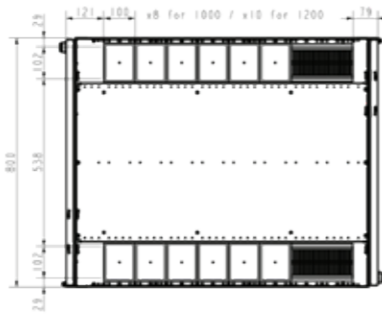

Top view

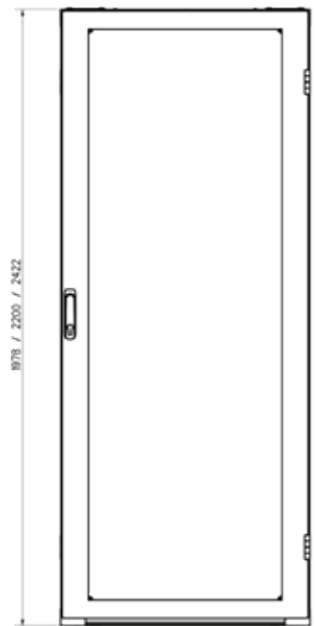
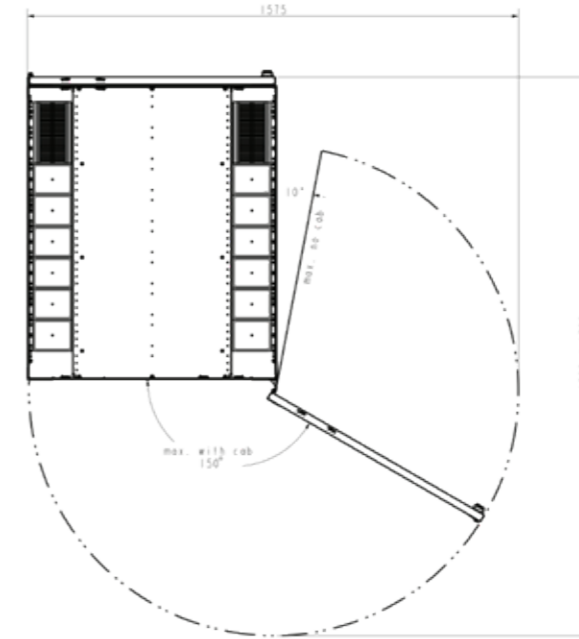
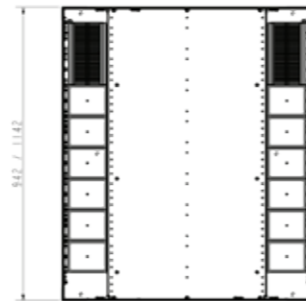

Total height

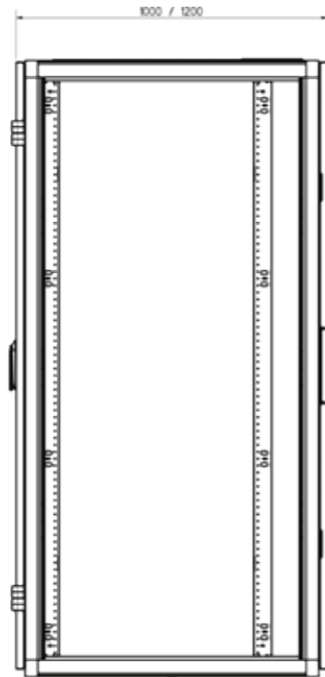

Side view with door

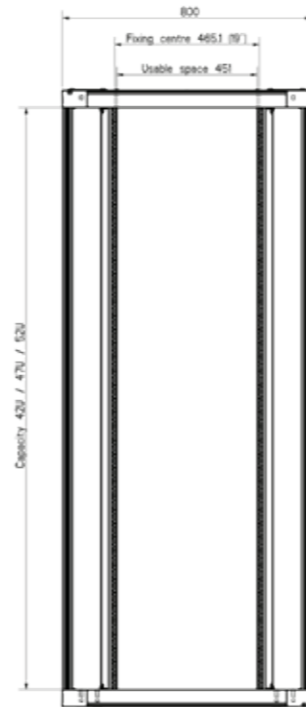

Front view

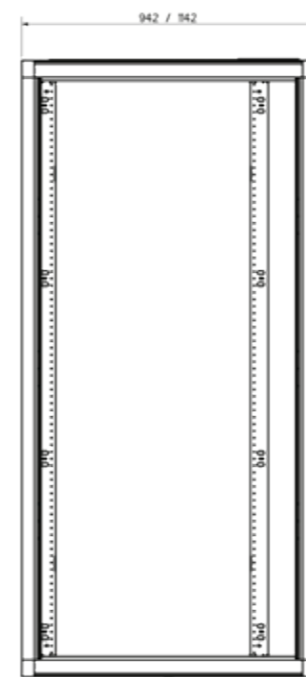

Side view without door

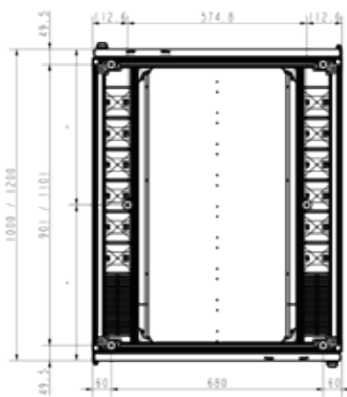

Bottom view

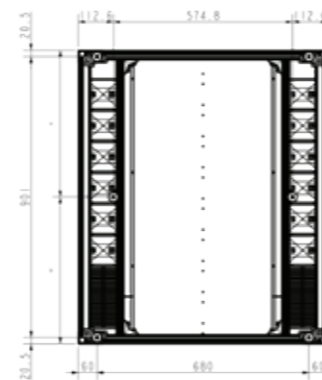

Bottom view

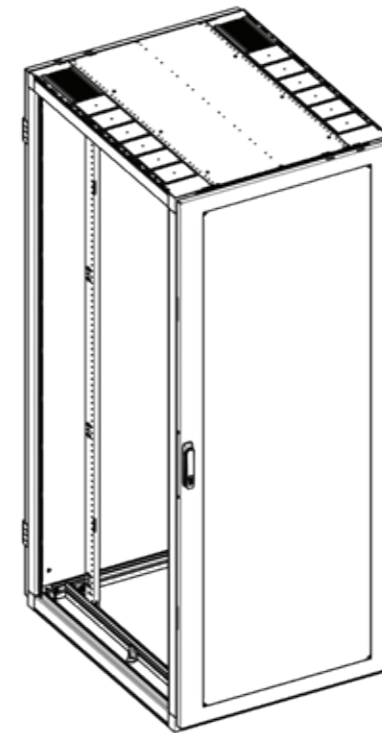

# NEXPAND

SERVER CABINET WITH AIRFLOW MANAGEMENT PACKAGE,  
CABLE TRAY AND SIDE PANELS 600 MM WIDE

Position vertical mounting rail

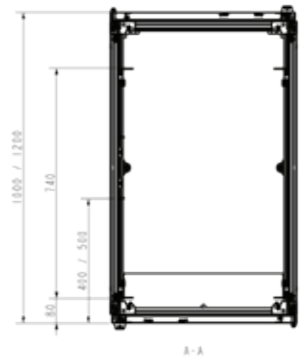

A-A

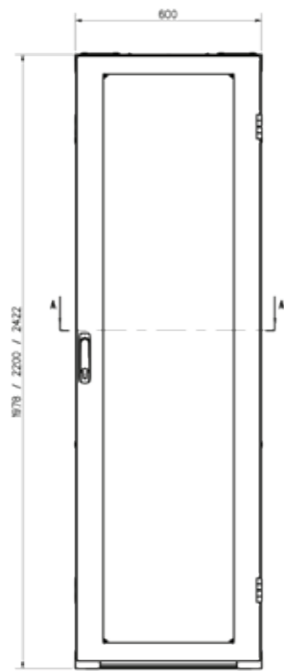

Total height

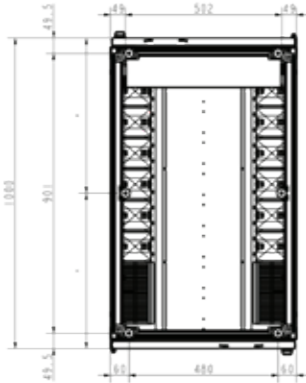

Bottom view

Top view

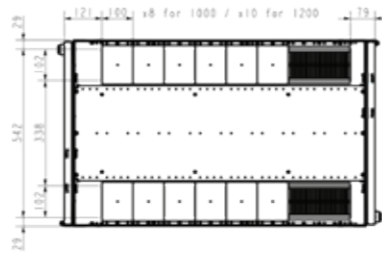

Top view

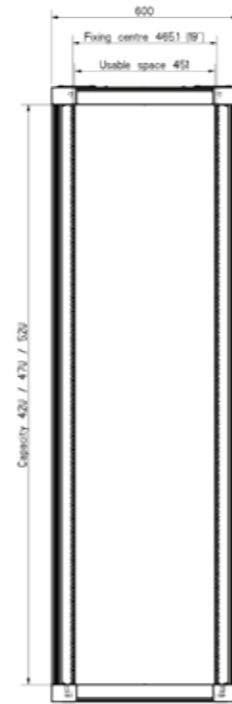
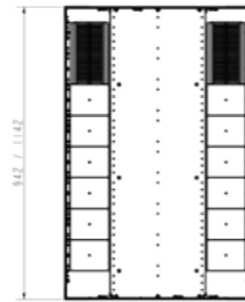

Front view

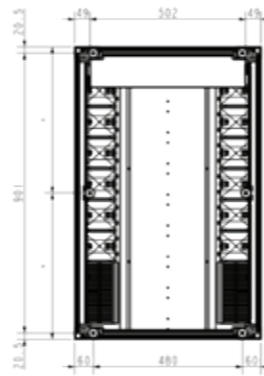

Bottom view

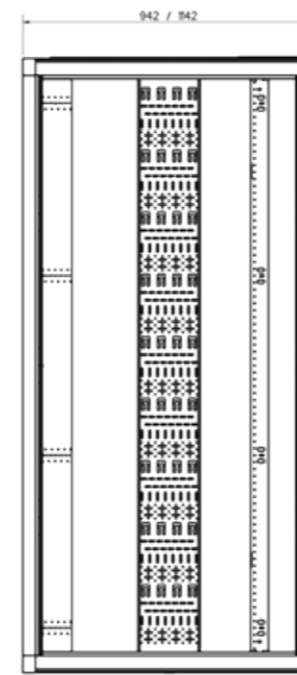

Side view without door

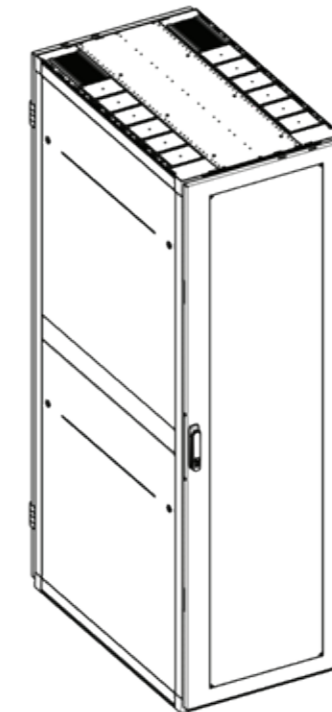
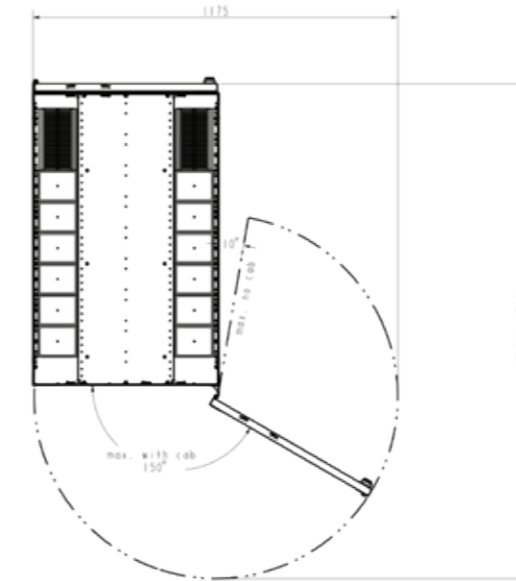

# NEXPAND

SERVER CABINET WITH AIRFLOW MANAGEMENT PACKAGE, CABLE TRAY AND SIDE PANELS 800 MM WIDE

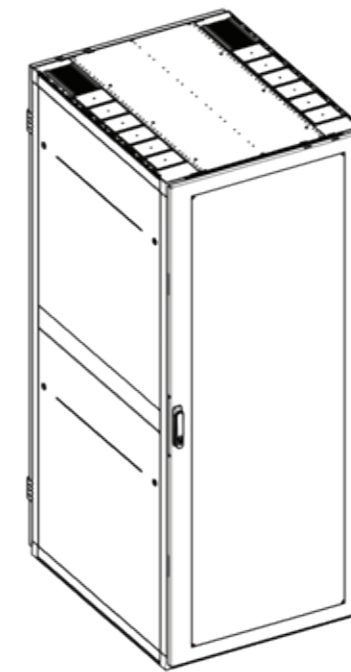
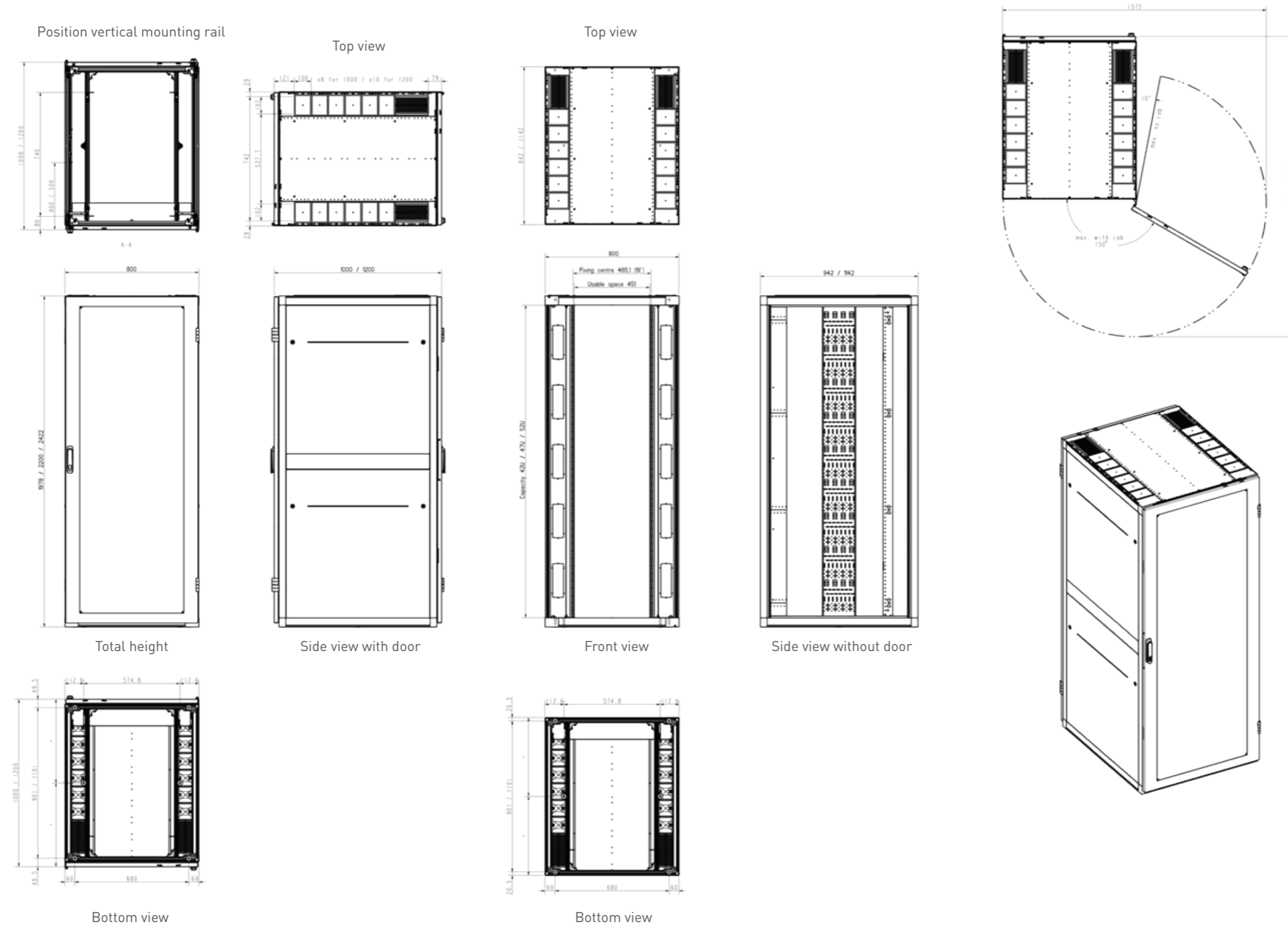



# NEXPAND

## Server cabinet



80% perforated single front door  
80% perforated single rear door

Height	Width (mm)	Depth (mm)	Black (RAL 9005)	White (RAL 9003)
42 U	600	1000	B1109-061042-000003	B1104-061042-000003
		1200	B1109-061242-000004	B1104-061242-000004
	800	1000	B1109-081042-000005	B1104-081042-000005
		1200	B1109-081242-000006	B1104-081242-000006
47 U	600	1000	B1109-061047-000007	B1104-061047-000007
		1200	B1109-061247-000008	B1104-061247-000008
	800	1000	B1109-081047-000009	B1104-081047-000009
		1200	B1109-081247-000010	B1104-081247-000010
52 U	600	1000	B1109-061052-000011	B1104-061052-000011
		1200	B1109-061252-000012	B1104-061252-000012
	800	1000	B1109-081052-000013	B1104-081052-000013
		1200	B1109-081252-000014	B1104-081252-000014

80% perforated single front door  
80% perforated double rear door

Height	Width (mm)	Depth (mm)	Black (RAL 9005)	White (RAL 9003)
42 U	600	1000	B1109-061042-000051	B1104-061042-000051
		1200	B1109-061242-000052	B1104-061242-000052
	800	1000	B1109-081042-000053	B1104-081042-000053
		1200	B1109-081242-000054	B1104-081242-000054
47 U	600	1000	B1109-061047-000055	B1104-061047-000055
		1200	B1109-061247-000056	B1104-061247-000056
	800	1000	B1109-081047-000057	B1104-081047-000057
		1200	B1109-081247-000058	B1104-081247-000058
52 U	600	1000	B1109-061052-000059	B1104-061052-000059
		1200	B1109-061252-000060	B1104-061252-000060
	800	1000	B1109-081052-000061	B1104-081052-000061
		1200	B1109-081252-000062	B1104-081252-000062

## Server cabinet

• Side panels



80% perforated single front door  
80% perforated single rear door

Height	Width (mm)	Depth (mm)	Black (RAL 9005)	White (RAL 9003)
42 U	600	1000	B1109-061042-000027	B1104-061042-000027
		1200	B1109-061242-000028	B1104-061242-000028
	800	1000	B1109-081042-000029	B1104-081042-000029
		1200	B1109-081242-000030	B1104-081242-000030
47 U	600	1000	B1109-061047-000031	B1104-061047-000031
		1200	B1109-061247-000032	B1104-061247-000032
	800	1000	B1109-081047-000033	B1104-081047-000033
		1200	B1109-081247-000034	B1104-081247-000034
52 U	600	1000	B1109-061052-000035	B1104-061052-000035
		1200	B1109-061252-000036	B1104-061252-000036
	800	1000	B1109-081052-000037	B1104-081052-000037
		1200	B1109-081252-000038	B1104-081252-000038

80% perforated single front door  
80% perforated double rear door

Height	Width (mm)	Depth (mm)	Black (RAL 9005)	White (RAL 9003)
42 U	600	1000	B1109-061042-000075	B1104-061042-000075
		1200	B1109-061242-000076	B1104-061242-000076
	800	1000	B1109-081042-000077	B1104-081042-000077
		1200	B1109-081242-000078	B1104-081242-000078
47 U	600	1000	B1109-061047-000079	B1104-061047-000079
		1200	B1109-061247-000080	B1104-061247-000080
	800	1000	B1109-081047-000081	B1104-081047-000081
		1200	B1109-081247-000082	B1104-081247-000082
52 U	600	1000	B1109-061052-000083	B1104-061052-000083
		1200	B1109-061252-000084	B1104-061252-000084
	800	1000	B1109-081052-000085	B1104-081052-000085
		1200	B1109-081252-000086	B1104-081252-000086

# NEXPAND

## Server cabinet

- Cable tray
- Airflow management package

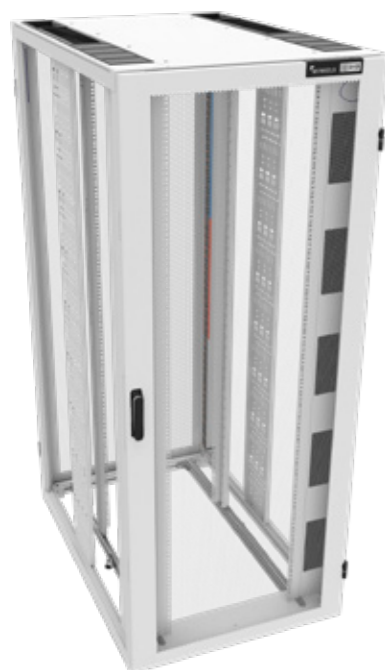

80% perforated single front door  
80% perforated single rear door

Height	Width (mm)	Depth (mm)	Black (RAL 9005)	White (RAL 9003)
42 U	600	1000	B1109-061042-000015	B1104-061042-000015
		1200	B1109-061242-000016	B1104-061242-000016
	800	1000	B1109-081042-000017	B1104-081042-000017
		1200	B1109-081242-000018	B1104-081242-000018
47 U	600	1000	B1109-061047-000019	B1104-061047-000019
		1200	B1109-061247-000020	B1104-061247-000020
	800	1000	B1109-081047-000021	B1104-081047-000021
		1200	B1109-081247-000022	B1104-081247-000022
52 U	600	1000	B1109-061052-000023	B1104-061052-000023
		1200	B1109-061252-000024	B1104-061252-000024
	800	1000	B1109-081052-000025	B1104-081052-000025
		1200	B1109-081252-000026	B1104-081252-000026

80% perforated single front door  
80% perforated double rear door

Height	Width (mm)	Depth (mm)	Black (RAL 9005)	White (RAL 9003)
42 U	600	1000	B1109-061042-000063	B1104-061042-000063
		1200	B1109-061242-000064	B1104-061242-000064
	800	1000	B1109-081042-000065	B1104-081042-000065
		1200	B1109-081242-000066	B1104-081242-000066
47 U	600	1000	B1109-061047-000067	B1104-061047-000067
		1200	B1109-061247-000068	B1104-061247-000068
	800	1000	B1109-081047-000069	B1104-081047-000069
		1200	B1109-081247-000070	B1104-081247-000070
52 U	600	1000	B1109-061052-000071	B1104-061052-000071
		1200	B1109-061252-000072	B1104-061252-000072
	800	1000	B1109-081052-000073	B1104-081052-000073
		1200	B1109-081252-000074	B1104-081252-000074

## Server cabinet

- Side panels
- Cable tray
- Airflow management package



80% perforated single front door  
80% perforated single rear door

Height	Width (mm)	Depth (mm)	Black (RAL 9005)	White (RAL 9003)
42 U	600	1000	B1109-061042-000039	B1104-061042-000039
		1200	B1109-061242-000040	B1104-061242-000040
	800	1000	B1109-081042-000041	B1104-081042-000041
		1200	B1109-081242-000042	B1104-081242-000042
47 U	600	1000	B1109-061047-000043	B1104-061047-000043
		1200	B1109-061247-000044	B1104-061247-000044
	800	1000	B1109-081047-000045	B1104-081047-000045
		1200	B1109-081247-000046	B1104-081247-000046
52 U	600	1000	B1109-061052-000047	B1104-061052-000047
		1200	B1109-061252-000048	B1104-061252-000048
	800	1000	B1109-081052-000049	B1104-081052-000049
		1200	B1109-081252-000050	B1104-081252-000050

80% perforated single front door  
80% perforated double rear door

Height	Width (mm)	Depth (mm)	Black (RAL 9005)	White (RAL 9003)
42 U	600	1000	B1109-061042-000087	B1104-061042-000087
		1200	B1109-061242-000088	B1104-061242-000088
	800	1000	B1109-081042-000089	B1104-081042-000089
		1200	B1109-081242-000090	B1104-081242-000090
47 U	600	1000	B1109-061047-000091	B1104-061047-000091
		1200	B1109-061247-000092	B1104-061247-000092
	800	1000	B1109-081047-000093	B1104-081047-000093
		1200	B1109-081247-000094	B1104-081247-000094
52 U	600	1000	B1109-061052-000095	B1104-061052-000095
		1200	B1109-061252-000096	B1104-061252-000096
	800	1000	B1109-081052-000097	B1104-081052-000097
		1200	B1109-081252-000098	B1104-081252-000098

On [www.minkels.com/technical-datasheets](http://www.minkels.com/technical-datasheets) you will find the technical data sheets containing extensive technical information about the different Nexpand cabinets. If you do not find the information you are looking for in these datasheets, do not hesitate to contact us. We will be happy to help you! You can find the contact details on the back side of this technical datasheet.



## FOLLOW US ON

@ website: [www.legrand.eg](http://www.legrand.eg)

f legrand

legrandegypt



**EMB Electrical Industries S.A.E.**

**Headquarter office**

Pyramids Heights Office Park  
KM 22 Cairo - Alex. desert road  
Building 1B, 12556  
Tel.: +202 3536 0000  
Fax: +202 3536 0001  
[www.legrand.eg](http://www.legrand.eg)