

PRODUCT GUIDE

SELECT YOUR DISTRIBUTION SYSTEM



GLOBAL SPECIALIST FOR ELECTRICAL
AND DIGITAL BUILDING INFRASTRUCTURES

 **legrand**[®]



LEGRAND DISTRIBUTION SYSTEMS

Distribution is an essential function for the electrical panels, as well as for control and circuit protection. As well as purely technical factors (intensity, number of outputs, etc.), the choice of a distribution system is critical regarding implementation, maintenance, operating requirements and possibility of evolving the panels.

To meet all specifications (practices, speed of implementation, ease of maintenance, continuity of service, etc.), Legrand offers three types of solutions: “Standard” distribution, “Optimised” distribution and “Increased Safety” distribution. All these solutions integrate perfectly with the Legrand power and protection range.



Contents

	The distribution systems at the heart of power offer.....	2
4-5		
Standard distribution	Universal solutions for traditional cabling.....	4
6-11		
Optimised distribution	Innovation for panel builders.....	6
	Optimised distribution in XL ³ 400 and 800 enclosures.....	8
	Optimised distribution in XL ³ 4000 enclosures.....	10
12-17		
Increased Safety distribution system	Increased Safety distribution system for high criticality sites.....	12
	The VX ³ IS and HX ³ IS distribution systems.....	14
	VX ³ IS and HX ³ IS bases and distribution blocks.....	16
18-49		
Catalogue pages		



DISTRIBUTION AT THE HEART OF POWER

With its XL³ enclosures, the DX³, DPX³, DPX, DMX³ ranges of circuit breakers and three types of distribution, Legrand offers powerful solutions adapted to every site.

SIMPLIFIED NAMING SYSTEM TO FACILITATE YOUR CHOICE:

HX³ **xxx**
Horizontal Max. rating
distribution

VX³ **xxx**
Vertical Max. rating
distribution

CHOOSE ONE OF LEGRAND'S THREE DISTRIBUTION SOLUTIONS



STANDARD DISTRIBUTION



HX³/VX³ OPTIMISED DISTRIBUTION

XL ³ enclosures	Supply busbars	Distribution blocks	Supports and busbars	VX ³ 63 and 125 A	HX ³ 125 A	HX ³ 80/125 A plug-in	HX ³ 400 A	VX ³ System
XL ³ 160	●	●		●	●	●		
XL ³ 400	●	●	●	●	●	●	●	●
XL ³ 800	●	●	●			●	●	●
XL ³ 4000	●	●	●			●	●	●

Supply busbars, distribution blocks, busbar supports: universal solutions for all types of panel up to 4000 A.
[See p.4](#)

THE UNIVERSAL SOLUTION FOR TRADITIONAL CABLING.

Distribution blocks and busbars specially designed to save time and space in XL³ cabinets and enclosures.
[See p. 6 to 11](#)

TIMESAVING AND INCREASED SAFETY

A COMPLETE RANGE FOR ALL ELECTRICAL PANELS



XL³ ENCLOSURES

A range of robust, easy-to-cable cabinets and enclosures, with a full choice of equipment and accessories for any size installation up to 6300 A.



CIRCUIT BREAKING AND PROTECTION

Several ranges of circuit breakers and switches, with a wide choice of breaking capacities and characteristics:

- DX³: modular circuit breakers up to 125 A,
- DPX³ and DPX: moulded case circuit breakers up to 1600A,
- DMX³: air circuit breakers up to 6300 A.



XL PRO³

Study software for designing Optimised and Increased Safety panels and selecting the right products.

HX³/VX³ IS INCREASED SAFETY DISTRIBUTION SYSTEM

VX³ / HX³-IS

For installations which require a large availability of energy, the Legrand Increased Safety distribution system offers three levels of service.

See p. 12 to 17

CONTINUITY OF SERVICE

UNIVERSAL SOLUTIONS FOR TRADITIONAL CABLING

The Legrand standard distribution can be installed in any kind of enclosure and respects working practices.

SUPPLY BUSBARS

They enable distribution to occur very rapidly on the level of each row, in total safety, in every panel. They perfectly complement the VX³ automatic connection vertical distribution blocks (see p. 7)

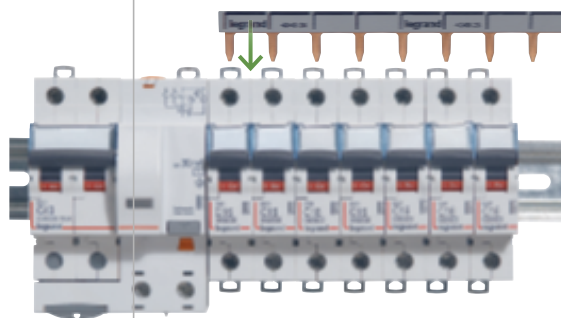

Supply busbars are available in one, two, three and four-pole versions and in several lengths.

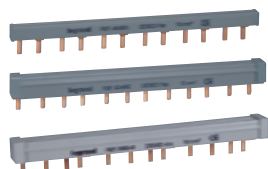

MODULAR DISTRIBUTION BLOCKS

These are mounted on the DIN rail, next to the devices, in all distribution panels. They allow complete freedom of distribution, using traditional cabling, up to 250 A. Their electrical and mechanical characteristics are a guarantee of safety.

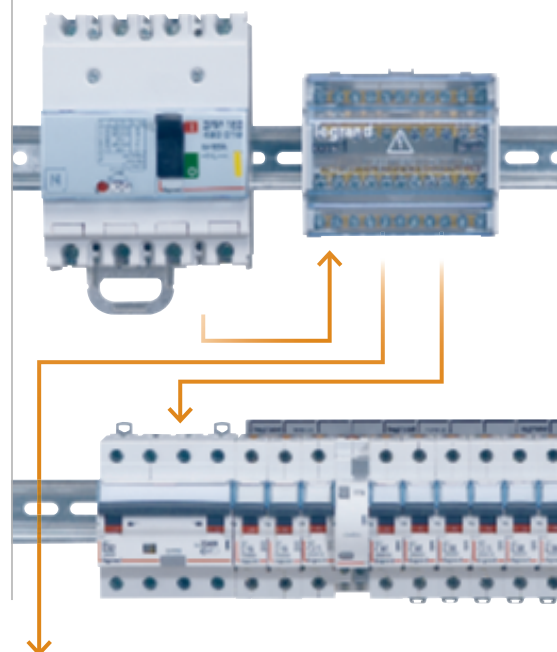

SUPPORTS AND BUSBARS

Busbars facilitate power distribution in enclosures from 400 to 6300 A. The various Legrand isolating supports enable numerous configurations to be used within an XL³ enclosure:

- vertical busbar on the side or at the back of the enclosure,
- vertical busbar in cable sleeve,
- horizontal busbar at top or bottom of the enclosure.

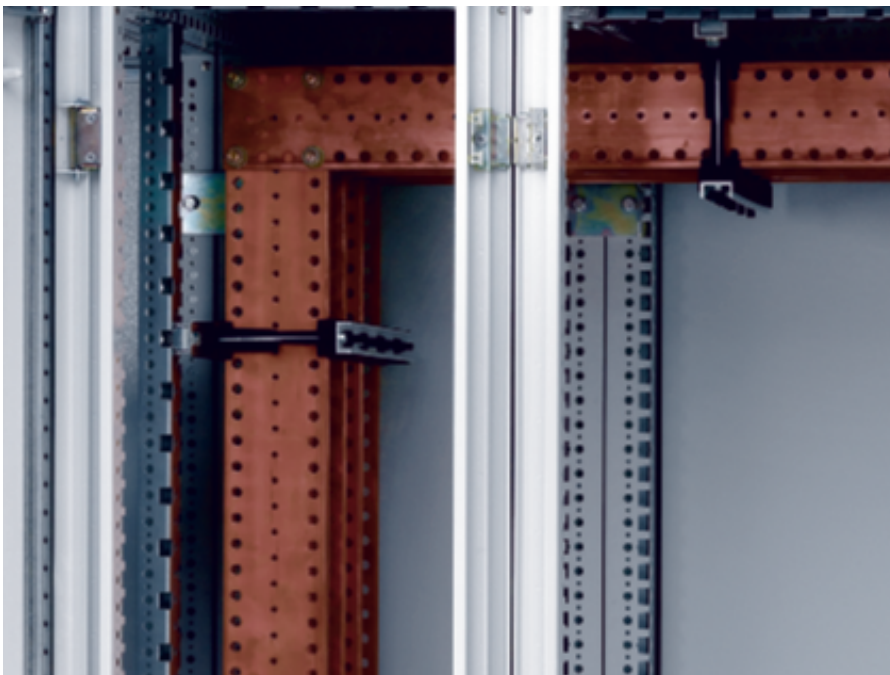

INPUT AND OUTPUT TERMINALS



COPPER/ALUMINIUM CONNECTION BOXES facilitate the preparation of power cable connections. They accept power cables up to 200 mm².



POWER TERMINAL BLOCKS facilitate the creation of output terminal blocks for high power outputs. Various versions are available: copper or aluminium cables, with or without lugs, copper bars.

INNOVATION FOR PANEL BUILDERS

Legrand optimised distribution is designed to facilitate the work of the panel builder.

It reduces fiddly cabling tasks and the need to make copper bars, which requires specialist tools.

The extent of the optimised solutions on offer allows all requirements to be met.

THE ADVANTAGES OF OPTIMISED DISTRIBUTION

TIMESAVING

- Automatic connections
- Prefabricated connection kits

SPACE SAVING

- COmpact system, fully integrated into XL³ enclosures
- Increased safety
- Less cabling, secure and lasting connections, IP XXB protection

HX³ 80/125 A WITH PLUG-IN CONNECTION

Horizontal 4-pole distribution blocks for XL³ 160, 400, 800 and 4000 cabinets and enclosures.

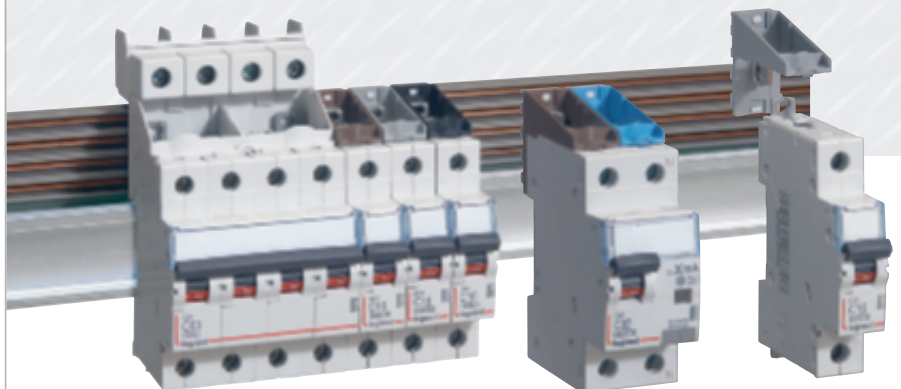

- Installation on aluminium DIN rails.
- Automatic, tool-free connection of upstream terminals to the distribution block, with no cabling or tightening, even when the distribution block is live but off-load. The power module itself cannot be handled when live.
- Freedom to mix 1P, 1P+N, 2P, 3P and 4P devices on the same row
- It is possible to supply the block via the four-pole power supply module or via the head of row MCB



Connection modules (L1, L2, L3, N).

The phases are balanced freely by choosing the right connection module.

VX³ 63 AND 125 A AUTOMATIC TERMINALS

Four-pole vertical distribution block to power modular rows in XL³ 125, 160 and 400 cabinets with 3-6 rows.

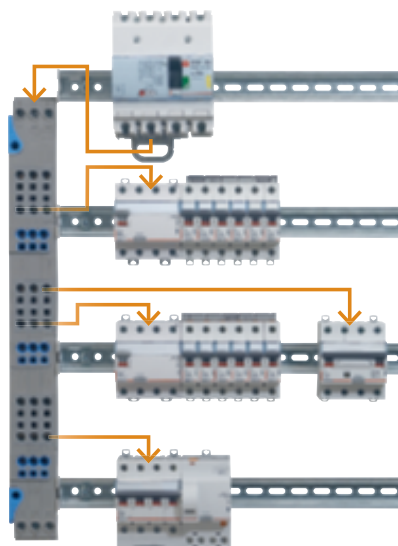

- Installation next to rows while maintaining full access to protection devices
- Direct connection with no additional accessories to IP XXB automatic terminals for flexible or rigid wires

HX³ 125 A WITH AUTOMATIC TERMINALS

Horizontal 4-pole distribution block for XL³ 160, 400, 800 and 4000 cabinets and enclosures.

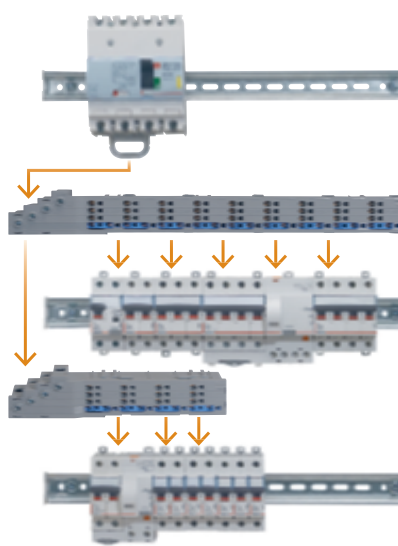

- Installation between rows of devices
- It is possible to mix 1P, 2P, 3P, 4P circuit breakers
- Automatic terminals IP XXB for flexible or rigid wires

AUTOMATIC TERMINALS: GUARANTEE OF SAFETY



Use of automatic connections saves time but it is also a guarantee of safety: no risk of loosening nor of forgetting to tighten a terminal.

OPTIMISED DISTRIBUTION IN XL³ 400 AND 800 ENCLOSURES

A system designed to make life simple for panel builders with **just three types of product:** vertical busbars, plug-in distribution blocks and connection kits.

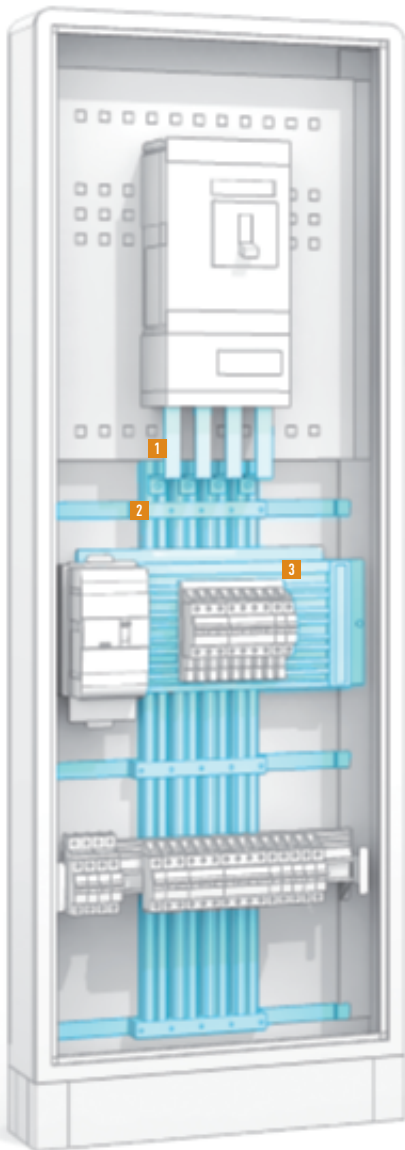

VX³ 400 OR VX³ 800 BUSBAR AT BACK OF ENCLOSURE



1 PREFABRICATED CONNECTION KIT connects the busbar to the main device mounted in a vertical position on the plate (up to 1600 A).



2 VX³ BUSBAR installed at back of enclosure: optimised dimensions. C-section tinned copper aluminium busbars using a special process which ensures electrochemical compatibility with the copper busbars.

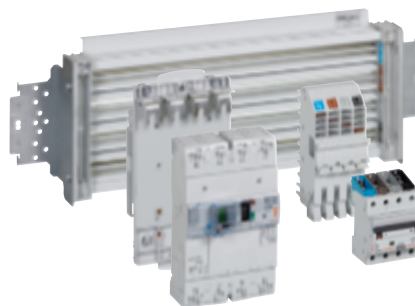

3 HX³ 250 A OR 400 A 3-POLE DISTRIBUTION BLOCK takes DPX³ and DX³ devices via plug-in support bases.

■ IP xxB distribution block with direct feed via busbar at rear of enclosure or via prefabricated kit and busbar in cable sleeve

■ Connection and disconnection of devices possible even when live but off-load.

■ Support base for device, made up of two parts:
- one fixed part which connects to the distribution block with crimps
- one mobile part which takes the device

VX³ 400 OR VX³ 800 BUSBAR IN CABLE SLEEVE

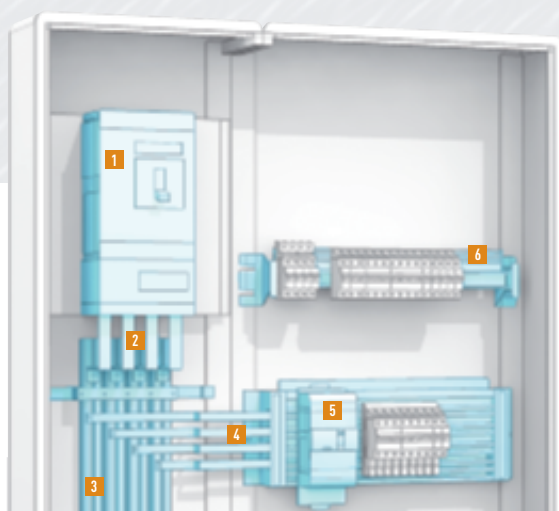

PROTECTION DEVICES IN VERTICAL POSITION

- 1 Main devices in cable sleeve
- 2 Prefabricated power supply kit (up to 630A)
- 3 VX³ 400 or 800 busbars
- 4 Connection kits for HX³ distribution blocks
- 5 DPX³ and DX³ devices on HX³ 250/400 row distribution blocks
- 6 Modular row with HX³ 80/125 A plug-in connection distribution block

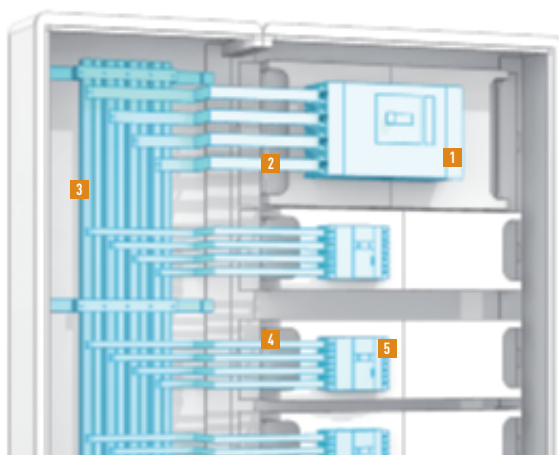

PROTECTION DEVICES IN HORIZONTAL POSITION

- 1 Main device in enclosure
- 2 Prefabricated power supply kit (up to 800A)
- 3 VX³ 400 or 800 busbars
- 4 Prefabricated connection kit
- 5 Plate-mounted device

OPTIMISED DISTRIBUTION IN XL³ 4000 ENCLOSURES

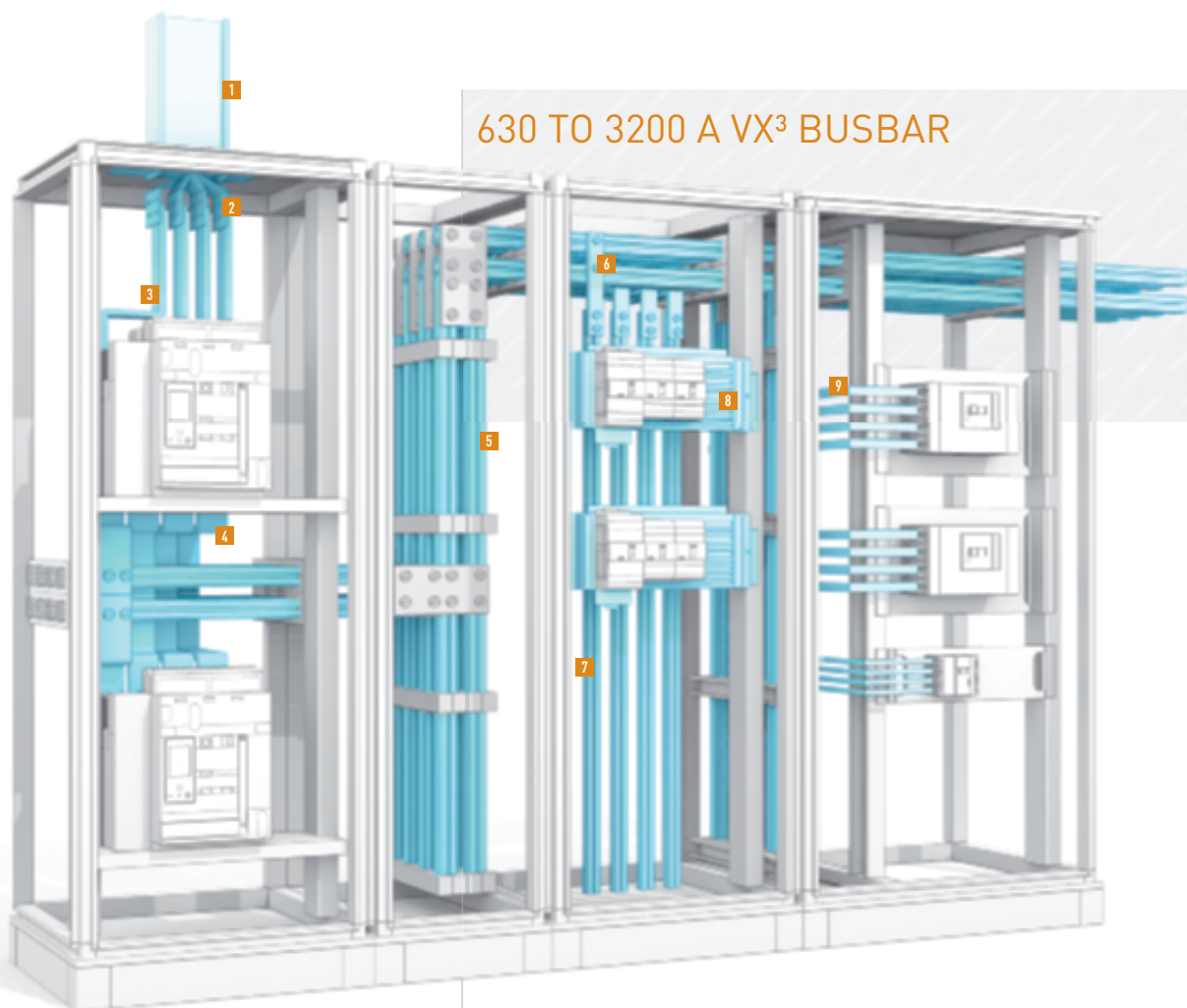

630 TO 3200 A VX³ BUSBAR

- 1 SCP busbar
- 2 Linking interface between XL³ 4000 enclosure and SCP busbars
- 3 DMX³ connection kit on SCP linking interface
- 4 Connection kits for transfer
- 5 VX³ 800/1600 busbar behind functional uprights or in cable sleeve
- 6 Connection kits for power supply for VX³ busbars
- 7 VX³ 800 busbar at back of enclosure
- 8 HX³ 400 A row distribution blocks
- 9 Prefabricated connection kits

EXAMPLE OF A COMPARATIVE STUDY OF A MAIN LV DISTRIBUTION BOARD FOR A SHOPPING CENTRE

DESIGNING THE PANEL

- Main protection device:
2 DMX³ as supply inverters
- Output protection:
3 DPX 630 4P, 5 DPX³ 250 4P, 5 DPX³ 160 4P, 3 DX³ 4P, 10 DX³ 2P

STANDARD DISTRIBUTION SOLUTION

Enclosures depth 975 mm and 2 external cable sleeves

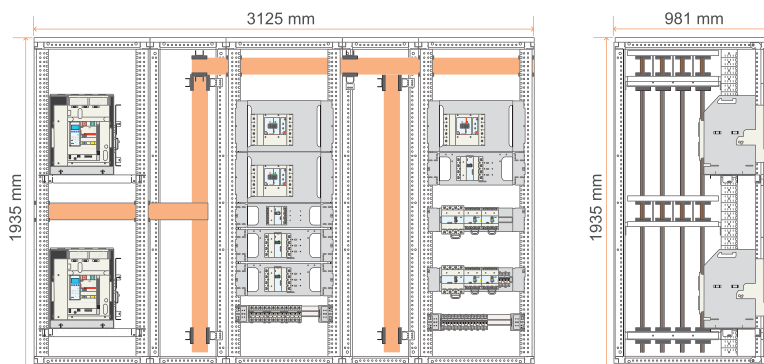

OPTIMISED DISTRIBUTION SOLUTION

Enclosures depth 725 mm, 1 external cable sleeve, 1 internal cable sleeve.

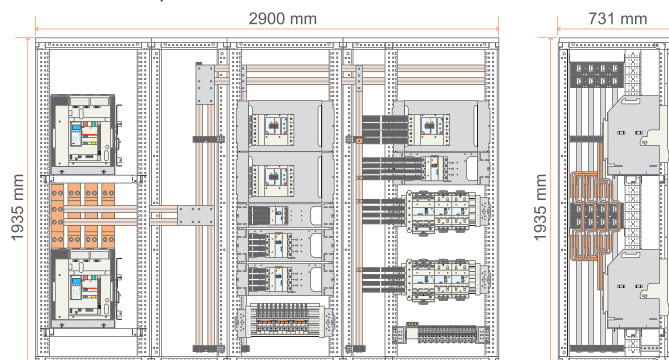

IN COMPARISON WITH THE STANDARD SOLUTION:

7 % LESS WIDE

25 % LESS DEEP

33 % FEWER WORKING HOURS

Not including the downstream connection of the DMX³ supply inverter and the connection of the modular devices and small DPX³ MCCBs

STUDY CONDUCTED WITH XL PRO³

Study software for designing Optimised and Increased Safety electrical panels and selecting the right products.



DISTRIBUTION

IS FOR HIGH CRITICALITY SITES

In light of increasing service continuity requirements, the ability to work on panels while they are live is crucial.

The Legrand Increased Safety distribution solutions offer an innovative response to service continuity requirements by providing a viable alternative to drawered enclosures.

THE IS SERVICE RATING

For the safety of persons, standard IEC 61439-1 & 2 defines two concepts: the forms of separation and the withdrawability index. Legrand goes further with the IS service rating. The three numbers of the IS service rating represent the level of response to service continuity requirements in three types of intervention: operation, maintenance and evolution.

1: low | **2**: medium | **3**: high

OPERATION IS X--

This figure shows the panel accessibility conditions for carrying out work on the installation.

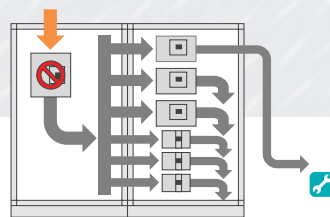

IS 1-- Complete shutdown of the panel.

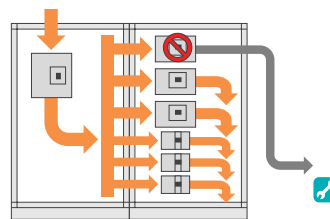

IS 2-- Complete stop of the functional unit concerned.

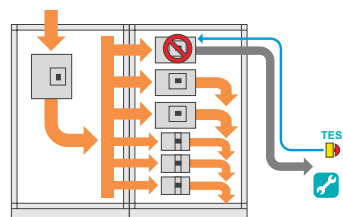

IS 3-- Cutoff power contacts of the functional unit concerned. Allows automation test, in order to check installation.

MAINTENANCE IS -X-

This figure shows the panel accessibility conditions for maintaining the installation.

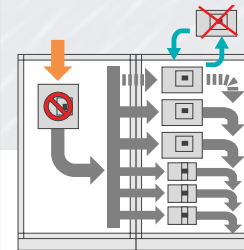

IS -1- Complete shutdown of the panel.

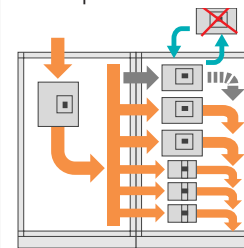

IS -2- Interruption limited to the functional unit concerned. The replacement requires an intervention on downstream connections.

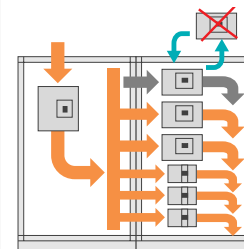

IS -3- Interruption limited to the functional unit concerned. The replacement will be completed without intervention on connections.

EVOLUTION IS --X

This figure shows the panel accessibility conditions for evolving the installation.

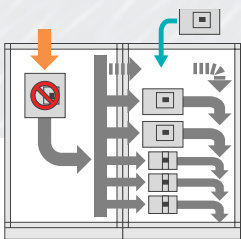

IS --1 Complete shutdown of the panel.

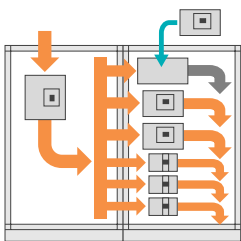

IS --2 Interruption limited to the functional unit concerned. Reserves of functional units are planned.

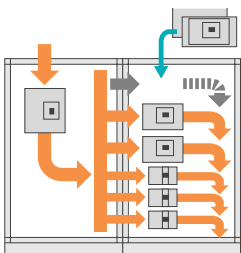

IS --3 Addition of any type of functional unit in an unequipped location, without powering off the panel.

FORMS OF SEPARATION

The forms of separation defined by IEC 61439-2 standard are the barriers to be put in place in distribution assemblies to ensure different levels of protection against contact with hazardous parts.

MAIN CRITERION	SUB-CRITERION	FORM
No internal separation		Form 1
Separation of busbars and functional units.	Terminals for external conductors not separated from busbars	Form 2a
	Terminals for external conductors separated from busbars	Form 2b
Separation of busbars and functional units and separation of all functional units from each other. Separation of terminals for external conductors from functional units but not the terminals for other functional units.	Terminals for external conductors not separated from busbars	Form 3a
	Terminals for external conductors separated from busbars	Form 3b
Separation of busbars and functional units and separation of all functional units from each other. Separation of terminals for external conductors associated with one functional unit from those of all the other functional units and the busbars.	Terminals for external conductors in the same compartment as the associated functional unit	Form 4a
	Terminals for external conductors which are not in the same compartment as the functional unit with which they are associated but in separate and enclosed protected spaces or individual compartments	Form 4b

WITHDRAWABILITY INDEX

The withdrawability index, according to standard IEC 61439-2, defines the type of electric connection for the functional units (FU).

1 ST LETTER	2 ND LETTER	3 RD LETTER
Type of electrical connection for the main incoming circuit	Type of electrical connection for the main outgoing circuit	Type of electrical connection for the auxiliary circuits

F = for fixed connections
D = for disconnectable connections
W = for withdrawable connections

Corresponds to the following types of circuit breakers: fixed, plug-in, draw-out

VX³ IS AND HX³ IS DISTRIBUTION SYSTEMS

With its new Increased Safety distribution system, Legrand offers three levels of service for so-called **high criticality sites where it is impossible to shut down the network for maintenance** (hospitals, computer rooms, etc.)

ADVANTAGES OF THE LEGRAND INCREASED SAFETY (IS) DISTRIBUTION SYSTEM:

TIMESAIVING

- Ease of fitting
- Ease of cabling (automatic feed crimping)

SIMPLICITY AND ECONOMY

- Responds to all levels of the IS service rating (ease of maintenance and evolution while live)
- It is possible to power motor controls
- IS 223 possible with modular devices
- Safety of intervention for users.

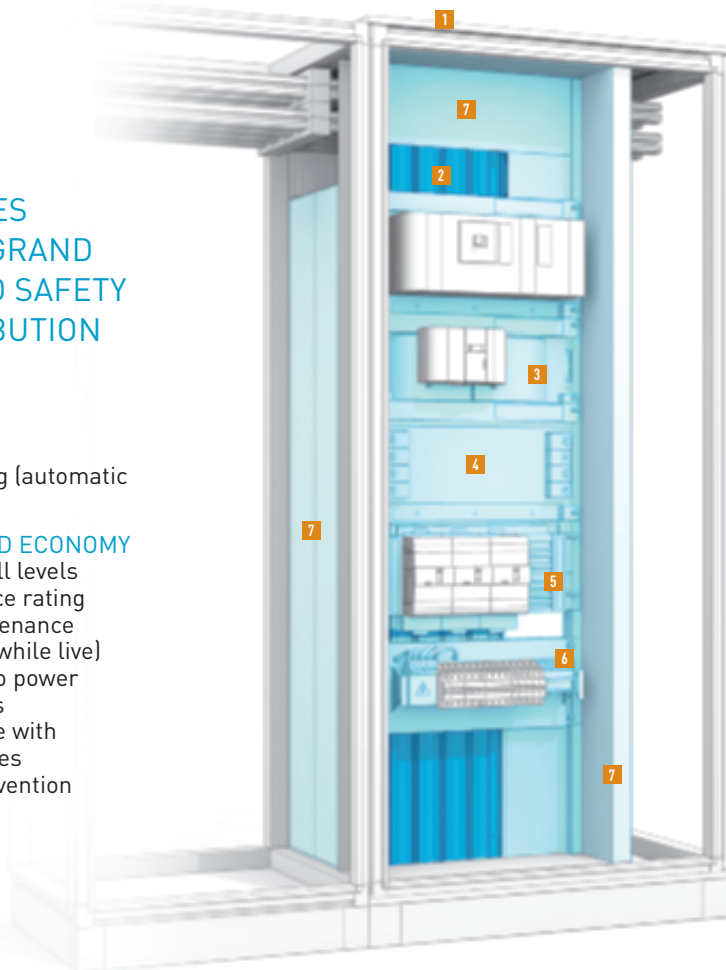

VX³ IS COLUMN CHASSIS

The tinned copper aluminium bars of the IS column chassis, thanks to their exclusive design, facilitate automatic connection of the IS bases ensuring the quality and longevity of the contacts.

- 1 XL³ 4000 enclosure, height 2200 mm, depth 725 or 975 mm
- 2 VX³ IS column chassis delivered with isolating profiles to ensure the IPXXB takes the VX³ IS bars (1250 A or 2000 A)
- 3 VX³ IS bases. The base is fixed on the VX³ IS column chassis. The withdrawable plate takes the protection device.
- 4 Universal bases (IS 223, 233 and 333), take any kind of functional unit
- 5 The HX³ IS 400 A row distribution block takes moulded case and modular devices
- 6 The HX³ IS 125 A row distribution block takes modular devices
- 7 Partitioning - facilitating forms 3b and 4b

Products may be handled when live but protection and switching devices must be off-load when being inserted or withdrawn.

CHOOSE YOUR SERVICE LEVEL FROM AMONG THE THREE LEGRAND INCREASED SAFETY (IS) SOLUTIONS

The three Legrand solutions offer everybody the possibility of adding new devices in unequipped locations, without cutting power to the panel, something that was unthinkable with traditional solutions (withdrawable forms and devices).

IS 223 (DDF, FORM 3B):

High criticality site, shutdown of functional unit permitted, requiring work on connections.

→ evolution of the installation while live:
it is possible to add a device without cutting power to the panel.

IS 233 (DDD, FORM 3B):

Highly critical site, power shutdown permitted for testing.

→ evolution + maintenance while live:
no intervention on the upstream connection,
no intervention on the downstream connection.

IS 333 (WWW, FORM 3B):

Extremely critical site, continuity of service essential

→ evolution + maintenance + operation while live:
position test to enable verification that the auxiliaries are functioning correctly.

SUMMARY OF THE LEGRAND RESPONSE

according to service index stringency levels

Minimum expected IS	Legrand IS solution	Maximum form in Legrand solution	Withdrawability Index in Legrand solution
111	Fixed versions ¹	4b	FFF
211	223	4b ²	DFF/DFD
221	223	4b ²	DFF/DFD
222	223	4b ²	DFF/DFD
223	223	4b ²	DFF/DFD
231	233	4b	DDD
232	233	4b	DDD
233	233	4b	DDD
311	333	4b	WWW
321	333	4b	WWW
322	333	4b	WWW
323	333	4b	WWW
331	333	4b	WWW
332	333	4b	WWW
333	333	4b	WWW

1: with rotary handle on door for main device
2: using external terminals

VX³ IS AND HX³ IS

BASES AND DISTRIBUTION BLOCKS

The IS bases for DPX and DPX³ and the universal bases satisfy levels IS 223, IS 233 and IS 333 service ratings. The IS distribution blocks satisfy level IS 223.

VX³ IS 223 BASE FOR DPX³ AND DPX CIRCUIT BREAKERS

- Upstream connection via the base
- Downstream connection directly to the circuit breaker terminals

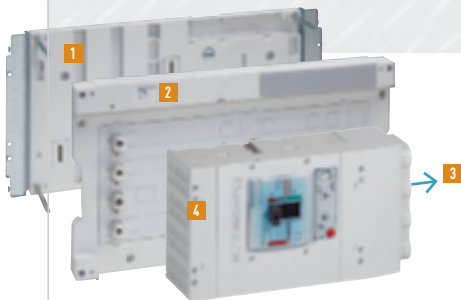

- 1 Base: direct connection to the column chassis
- 2 Withdrawable plate: takes the device and slots into the base
- 3 Downstream connection
- 4 Terminal shield

- It is possible to add a functional unit while live.
- Replacement of a functional unit in less than one hour.

VX³ IS 233 BASE FOR DPX³ AND DPX CIRCUIT BREAKERS

- Upstream connection via the base
- Downstream connection via the base

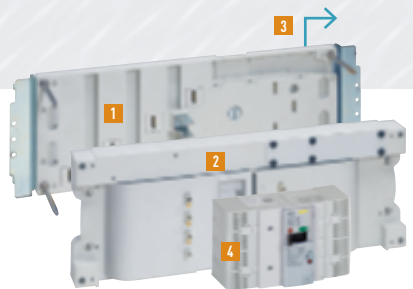

- 1 Base: direct connection to the column chassis
- 2 Withdrawable plate: takes the device and slots into the base
- 3 Downstream connection
- 4 Terminal shield

- It is possible to add a functional unit while live.
- Replacement of a functional unit in less than quarter of an hour.

VX³ IS 333 BASE FOR DPX³ AND DPX CIRCUIT BREAKERS

- Upstream connection via the base
- Downstream connection via the base
- Connection of auxiliaries on withdrawable connector

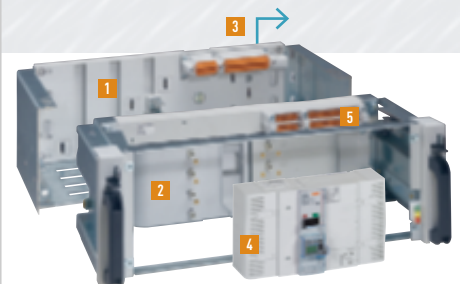

- 1 Base: direct connection to the column chassis
- 2 Withdrawable plate: takes the device and slots into the base
- 3 Downstream connection
- 4 Terminal shield
- 5 Withdrawable connector for auxiliary circuits

- It is possible to add a functional unit while live.
- Replacement of a functional unit in less than quarter of an hour.
- Lockout of the functional unit to allow testing of off-load auxiliary circuits.

125 A HX³ IS 223 DISTRIBUTION BLOCK

- For DX³ circuit breakers
- Upstream connection via the distribution block
- Downstream connection directly to the circuit breaker terminals

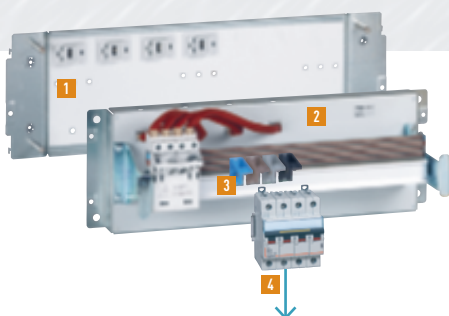

- 1** Base: direct connection to the column chassis
- 2** Withdrawable distribution block: takes the devices equipped with support bases, slots into the base and ensures the upstream connection of the devices
- 3** Connectors for modular devices
- 4** Downstream connection

- It is possible to add a device while live.
- It is possible to add a row while live.
- Replacement of a functional unit in less than one hour.

400 A HX³ IS 223 DISTRIBUTION BLOCK

- For DX³ and DPX³ circuit breakers
- Upstream connection via the distribution block
- Downstream connection directly to the circuit breaker terminals

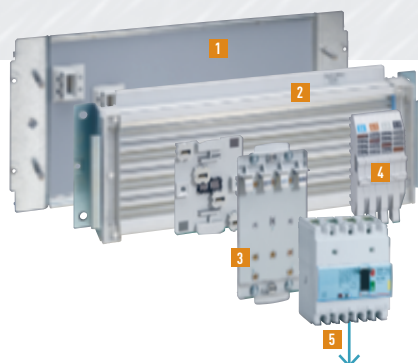

- 1** Base: direct connection to the column chassis
- 2** Withdrawable distribution block: takes the devices equipped with support bases, slots into the base and ensures the upstream connection of the devices
- 3** DPX³ support base
- 4** Modular support base
- 5** Downstream connection

- It is possible to add a device while live.
- Possible addition of a row while live.
- Replacement of a functional unit in less than one hour.

UNIVERSAL BASES IS 223, IS 233 AND IS 333:

Allowing devices which do not have a dedicated base to be mounted (for example, motor contactors).

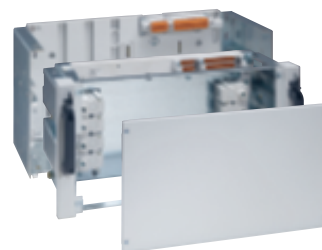

Supply busbars and distribution blocks

SUPPLY BUSBARS FROM 63 TO 90 A

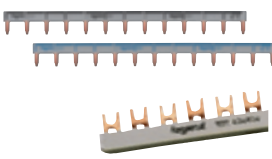
• Isc peak 17 kA 	Lenght	Universal 1-pole + neutral or 1-pole	2-pole	2-pole balanced on 3-phase	3-pole	4-pole
	Prong-type					
	1 row	4 049 26	4 049 38	4 049 40	4 049 42	4 049 44
meter	4 049 37	4 049 39	4 049 41	4 049 43	4 049 45	
Fork-type						
1 row	4 049 11	-		4 049 17	-	
meter	4 049 12	4 049 14		4 049 18	4 049 20	

DISTRIBUTION TERMINAL BLOCKS FROM 63 TO 100 A

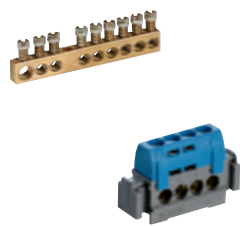
• Isc peak 10 kA 	Number of outputs	Bar terminal blocks		Insulated terminal blocks IP 2X (XXB)		
		with screws	on support	black	blue	green
4	0 048 01	0 048 20	0 048 50	0 048 40	0 048 30	
6			0 048 16	0 048 15		
8	0 048 03	0 048 22	0 048 52	0 048 42	0 048 32	
12		0 048 24	0 048 54	0 048 44	0 048 34	
14	0 048 05					
16		0 048 25		0 048 45	0 048 35	
19	0 048 06					
21		0 048 26		0 048 46	0 048 36	
24	0 048 07					
33		0 048 28		0 048 48	0 048 38	

MODULAR DISTRIBUTION BLOCKS FROM 40 TO 250 A

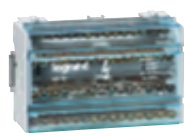
• Isc peak 14.5 to 42 kA 	Admissible maximum rating (A)	2-pole			4-pole			Terminal blocks IP 2X		
		Number and section of flexible conductors (mm ²)			Number and section of flexible conductors (mm ²)			Additional outputs		
		Cat.Nos	Inputs	Outputs	Cat.Nos	Inputs	Outputs	Earth	Neutral	(mm ²)
40	0 048 81	2 x 10	11 x 4	0 048 85	2 x 10	11 x 4	0 048 34	0 048 44	12 x 6	
100	0 048 80	2 x 16	5 x 10	0 048 84	2 x 16	5 x 10	0 048 32	0 048 42	8 x 6	
125	0 048 82	2 x 25	2 x 16 + 11 x 10	0 048 86	2 x 25	2 x 16 + 7 x 10	0 048 35	0 048 44	12 x 6	
	0 048 88			0 048 88	2 x 25	2 x 25 + 11 x 10		0 048 45	16 x 6	
160				0 048 76	1 x 35	1 x 25 + 1 x 16 + 14 x 10		0 048 46	21 x 6	
				0 048 79	1 x 70	2 x 25 + 4 x 16 + 8 x 10		0 048 45	16 x 6	
250				0 048 77	1 x 120	1 x 35 + 2 x 25 + 2 x 16 + 6 x 10				

SINGLE POLE MODULAR DISTRIBUTION BLOCKS AND DISTRIBUTION TERMINALS FROM 125 TO 250 A

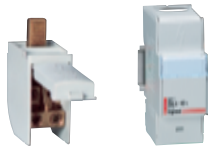
• Isc peak 27 to 60 kA 	Admissible maximum rating (A)	Cat.Nos	Number and section of conductors per pole (mm ²)	
			Inputs	Outputs
125		0 048 71	4 x 35	12 x 10
160		0 048 83	1 x 50 (flexible bar 13 mm max.)	3 x 25 + 2 x 16 + 7 x 10
		0 048 67 (distribution terminal)	Direct into the downstream terminal	6 x 25
250		0 048 73	1 x 120 (flexible bar 16 mm max.)	6 x 25 + 4 x 10
		0 048 68 (distribution terminal)	Direct into the downstream terminal	4 x 35 + 2 x 25

POWER DISTRIBUTION BLOCKS FROM 125 TO 400 A

• Isc peak 20 to 75 kA 	Admissible maximum rating (A)	Extra-flat			Stepped		
		Number and section of conductors per pole (mm ²)			Number and section of conductors per pole (mm ²)		
		Cat.Nos	Inputs	Outputs	Cat.Nos	Inputs	Outputs
125	0 374 47	1 x 35	10 x 16 (Ph) 17 x 16 (N)	0 373 95	4 bars 12 x 4 mm receiving 5 connectors 2 x 10 each		
				0 374 30	1 x 35	5 x 25	
160				0 374 31	1 x 70	5 x 35	
250	0 374 00	1 x 150	1 x 70 or 1 x 50 + 1 x 35 or 2 x 35	0 374 35	1 x 120	5 x 50	
400				0 373 08	2 x Ø8.5 mm	21 holes M6 70 mm ² max. connectors	
				0 374 42	2 x 185	15 holes M6 15 holes M8	

Supply busbars, entry terminals

"standard" distribution

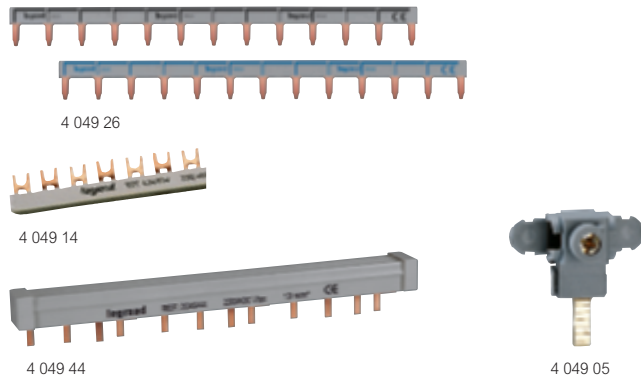

Pack Cat.Nos Prong-type supply busbars

Pack	Cat.Nos	Configuration	Length	Max. number of devices connected	Diagram
20	4 049 26	Universal single pole + neutral	1 row	13	
	4 049 37	Reversible: blue for neutral, black for live	Meter	57	
50	4 049 38 ¹	Double pole	1 row	6	
	4 049 39	Meter	Meter	28	
3	4 049 40 ¹	Double pole balanced on 3 phases	1 row	6	
	4 049 41	Meter	Meter	28	
40	4 049 42 ¹	Triple pole	1 row	4	
	4 049 43	Meter	Meter	19	
30	4 049 44	Four pole	1 row	3	
	4 049 45	Meter	Meter	14	

Fork-type supply busbars

Pack	Cat.Nos	Configuration	Length	Max. number of devices connected	Diagram
20	4 049 11	Single pole	1 row	12	
	4 049 12	Meter	Meter	57	
10	4 049 14	Double pole	Meter	28	
5	4 049 17	Triple pole	1 row	4	
	4 049 18	Meter	Meter	19	
10	4 049 20	Four pole	Meter	14	

Protection

20	4 049 88	Protection of prongs	12 modules	Can be cut to length	
40	4 049 89	Protection of supply busbar ends	For single pole/single pole + neutral		
20	4 049 90		For double pole length 1 m and triple pole		
20	4 049 91		For four-pole		

Entry terminals

20	4 049 05	For universal single pole + neutral or single pole supply busbars	Cross section: 4 to 25 mm ² - IP 2X		
20	4 049 06	For all supply busbars	Cross section: 6 to 35 mm ²		

1: Filled with end protection

Supply busbars, entry terminals

"standard" distribution

Technical characteristics

Busbars types	Max. number of devices connected	Length in number of 17.5 mm modules	Cross section (mm ²)	Permissible current:	
				1 central power supply point	2 power supply point
Single pole or Single pole + neutral	1 row	13	162	80	100
	Meter	57			
Double pole	1 row	6	102	63	90
	Meter	28	162	80	100
Double pole balanced on 3-phases	1 row	6	102	63	90
	Meter	28	162	80	100
Triple pole	1 row	4	102	63	90
	Meter	19	162	80	100
Four pole	1 row	3	102	63	90
	Meter	14	162	80	100

Use of supply busbars

Universal single phase + neutral

- blue for neutral
- black for live

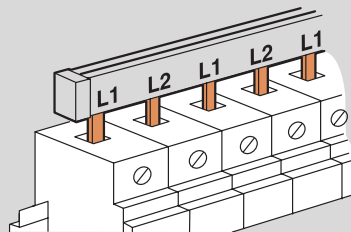

Entry terminal

Power supply at the rear of the busbar
For all devices with moving cage terminals

Power supply at the front of the busbar
For all devices with fixed cage terminals

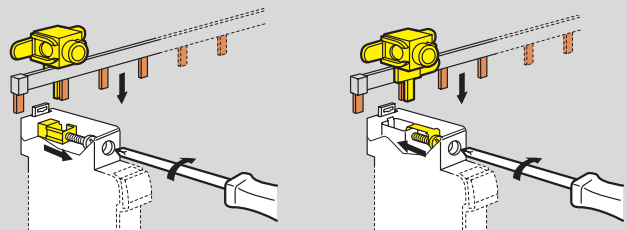

Four pole busbar

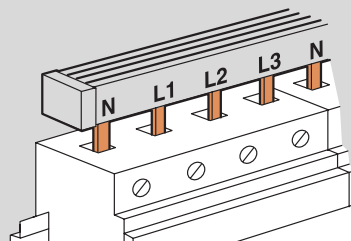

Distribution terminal blocks

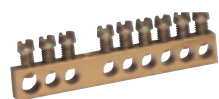

0 048 03



0 048 22



0 048 15

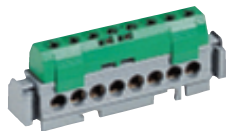

0 048 32

Pack	Cat.Nos	Distribution terminal blocks	
		Conform to standard IEC 60998-2-1 Supplied ready for use (screws not tightened) 100 A max. - 400 V~ with 25 mm ² input 80 A max. - 400 V~ with 16 mm ² input	
		Screw terminal blocks	
		Fit with Ø M4 screws	
		Number of connections (mm ²)	Length (mm)
10	0 048 01	1 x 6 to 25 + 4 x 1.5 to 16	45
10	0 048 03	1 x 6 to 25 + 8 x 1.5 to 16	73
10	0 048 05	1 x 6 to 25 + 14 x 1.5 to 16	122
10	0 048 06	1 x 6 to 25 + 19 x 1.5 to 16	157
10	0 048 07	1 x 6 to 25 + 25 x 1.5 to 16	192
		Terminal blocks on support	
		Mounting on or rail with universal support Cat.No 0 048 11, or on 12 x 2 flat bar Supplied with Duplix markers	
10	0 048 20 ¹	4 x 1.5 to 16	47
10	0 048 22 ¹	8 x 1.5 to 16	75
10	0 048 24 ¹	1 x 6 to 25 + 12 x 1.5 to 16	113
10	0 048 25 ¹	1 x 6 to 25 + 16 x 1.5 to 16	141
10	0 048 26 ¹	1 x 6 to 25 + 21 x 1.5 to 16	176
10	0 048 28 ¹	1 x 6 to 25 + 33 x 1.5 to 16	276
		IP 2X terminal blocks	
		Mounting on or rail with universal support Cat.No 0 048 11, or on 12 x 2 flat bar	
10	0 048 16	1 x 10 to 35 + 5 x 6 to 25	62
10	0 048 50	4 x 1.5 to 16	47
10	0 048 52	8 x 1.5 to 16	75
10	0 048 54	1 x 6 to 25 + 12 x 1.5 to 16	113
10		0 048 45	1 x 6 to 25 + 16 x 1.5 to 16
10		0 048 46	1 x 6 to 25 + 21 x 1.5 to 16
10		0 048 48	2 x 6 to 25 + 33 x 1.5 to 16
		Earth (green)	
10	0 048 30	4 x 1.5 to 16	47
10	0 048 32	8 x 1.5 to 16	75
10	0 048 34	1 x 6 to 25 + 12 x 1.5 to 16	113
10	0 048 35	1 x 6 to 25 + 16 x 1.5 to 16	141
10	0 048 36	1 x 6 to 25 + 21 x 1.5 to 16	176
10	0 048 38	2 x 6 to 25 + 33 x 1.5 to 16	276

Pack	Cat.Nos	Supports for terminal blocks
1	0 048 10	Distribution block support for connecting up to 4 IP 2X terminal block of the same size to create a distribution block
5	0 048 11	Universal support for mounting an terminal blocks on or rail
5	0 048 17	35-holes empty support, for screw terminal blocks Length: 276 mm

Pack	Cat.Nos	Flat bar 12 x 2
10	0 048 19	Length: 1 meter

1: Each terminal block is supplied with:
 - 2 green Duplix marked \perp - 2 blue Duplix marked N
 - 2 red Duplix marked L

Distribution terminal blocks

Mounting of terminal blocks on support

On 12 x 2 flat bar



On support for terminal blocks Cat.No 0 048 17

Enables you to make exactly the right number of connections

• Example:

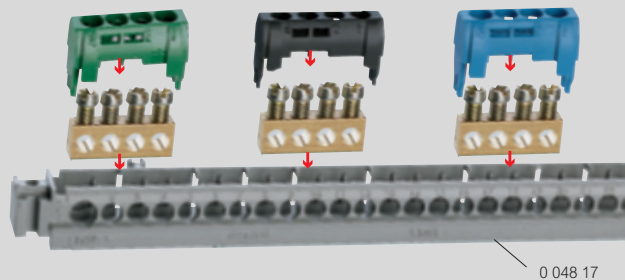

Universal support Cat.No 0 048 11

Mounted on or rail, takes all terminal blocks

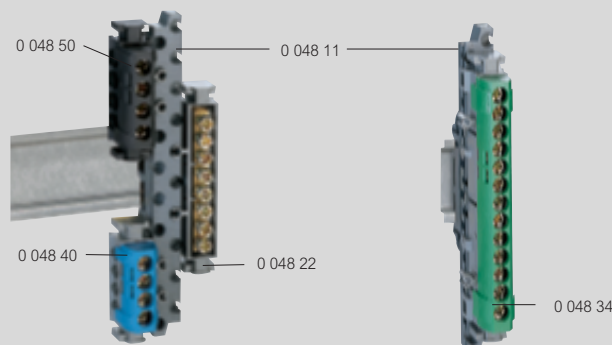

On distribution block support Cat.No 0 048 10

Possibility of forming a 2P, 3P or 4P distribution block by associating IP 2X terminal blocks

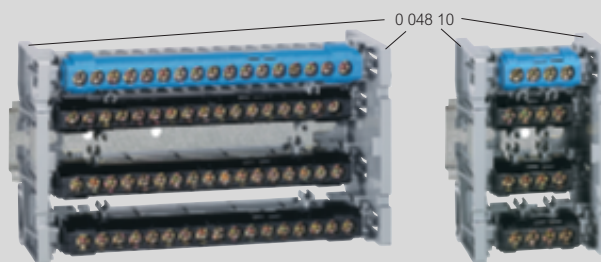

Modular distribution blocks

40 to 250 A

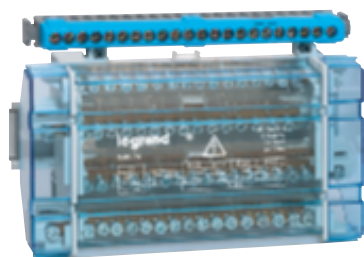

0 048 76 + 0 048 46

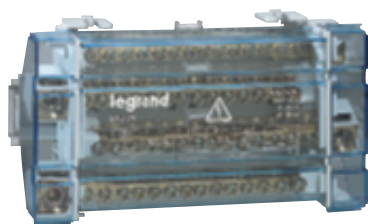

0 048 79

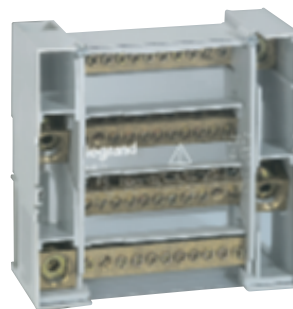

0 048 77



0 048 83

Technical characteristics p. 22-24

Standard distribution
 Connection with or without Starfix ferrules
 Self-extinguishing, according to EN 60695-2-11: 960 °C on active part supports

Pack	Cat.Nos	Monobloc modular distribution blocks					
		Mounting on rail or on plate with 2 screws Supplied with insulated back plate and transparent protective front cover Each bar can be labelled using CAB 3 Possible to add IP 2X terminal block (except Cat.No 0 048 77)					
		Double pole					
		Equipped with 2 bars					
		Rating (A)	Connections per bar		Isc peak (kA)	Icw (kA)	Number of modules
			rigid (mm ²)	flexible (mm ²)			
5	0 048 81	40	11 x 1.5 to 4 2 x 6 to 16	11 x 0.75 to 4 2 x 4 to 10	20	3	6
10	0 048 80	100	5 x 2.5 to 10 2 x 10 to 25	5 x 1.5 to 10 2 x 6 to 16	20	4.5	4
5	0 048 82	125	11 x 2.5 to 10 2 x 10 to 25 2 x 10 to 35	11 x .5 to 10 2 x 6 to 16 2 x 10 to 25	18	4.5	8
		Four pole					
		Equipped with 4 bars					
		Rating (A)	Connections per bar		Isc peak (kA)	Icw (kA)	Number of modules
			rigid (mm ²)	flexible (mm ²)			
5	0 048 85	40	11 x 1.5 to 4 2 x 6 to 16	11 x 0.75 to 4 2 x 4 to 10	20	3	6
10	0 048 84	100	5 x 2.5 to 10 2 x 10 to 25	5 x 1.5 to 10 2 x 6 to 16	20	4.5	4
5	0 048 86	125	7 x 2.5 to 10 2 x 10 to 25 2 x 10 to 35	7 x 1.5 to 10 2 x 6 to 16 2 x 10 to 25	20	4.5	6
5	0 048 88 ¹	125	11 x 2.5 to 10 4 x 10 to 35	11 x 1.5 to 10 4 x 6 to 25	14.5	4.2	8
1	0 048 76 ²	125	14 x 2.5 to 10 1 x 10 to 25 1 x 10 to 35 -	14 x 1.5 to 10 1 x 6 to 16 1 x 6 to 25 1 x 16 to 35	20	4.5	10
1	0 048 79 ¹	160	8 x 2.5 to 10 4 x 10 to 25 2 x 10 to 35 1 x 35 to 70	8 x 1.5 to 10 4 x 6 to 16 2 x 10 to 25 1 x 35 to 70	27	8.4	10
1	0 048 77	250	6 x 2.5 to 16 2 x 10 to 25 2 x 10 to 35 1 x 16 to 50 1 x 50 to 120	6 x 2.5 to 10 2 x 6 to 16 2 x 10 to 25 1 x 16 to 35 1 x 50 to 120	42	14.4	9

Pack	Cat.Nos	Modular distribution blocks					
		Mounting on rail Fitted with Lexic label holder Can be joined together Possibility of forming a four pole distribution block by adding modules					
		Single pole					
		Rating (A)	Connections per bar		Isc peak (kA)	Icw (kA)	Number of modules
			rigid (mm ²)	flexible (mm ²)			
4	0 048 71	125	4 x 16 to 50 12 x 1.5 to 10	4 x 16 to 35 12 x 1.5 to 10	35		2
4	0 048 83	160	1 x 35 to 70 7 x 2.5 to 10 2 x 6 to 25 3 x 10 to 35	1 x 25 to 50 7 x 1.5 to 6 2 x 6 to 16 3 x 10 to 25	27		2
4	0 048 73	250	1 x 70 to 150 4 x 2.5 to 16 6 x 10 to 35	1 x 70 to 120 4 x 2.5 to 10 6 x 10 to 25	60		2
		Distribution terminals					
							Isc peak (kA)
1	0 048 67	160 A - 6 outputs 25 mm ² flexible				30	
		Can be fitted directly onto downstream terminal of DPX ³ 160, Vistop 100/160 A and DX H 125 A					
1	0 048 68	250 A - 4 outputs 35 mm ² flexible and 2 outputs 25 mm ² flexible				36	
		Can be fitted directly onto downstream terminal of DPX ³ 250 ER and DPX-IS 250					

1: With short ferrule supplied for flexible connection 25 mm²
 2: Incoming conductors must be equipped with ferrules
 Connection: 25 mm² with ferrules without insulating flange

Power distribution blocks





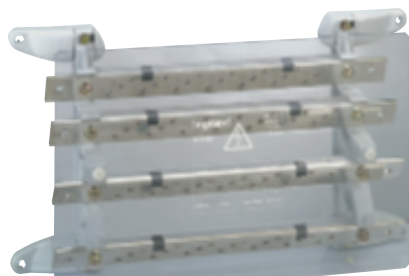



0 374 00



0 373 08

"Standard" distribution
Supplied with screen protection

Pack	Cat.Nos	Extra-flat for lugs
1	0 374 47	125 A Fixing on rail EN 60715  or on plate with M6 screws. Equipped with: - 1 incoming 35 mm ² (possible tapp-off) - 10 phase outgoing 16 mm ² - M5 screws - 17 neutral outgoing 16 mm ² - M5 screws Connection possible using connector Cat.No 0 373 65
1	0 374 00	250 A Fixing on plain plate or on plate with M6 screws Distribution block 1 incoming 150 mm ² per pole: - 1 pole is composed of 3 parts - Each part can receive: 1 x 70 mm ² or 1 x 50 mm ² and 1 x 35 mm ² , or 2 x 35 mm ² or 1 connector with 3 outgoing terminals Cat.No 0 374 03 (p. 25)
Stepped for lugs		
1	0 373 95	125 A Fixing on rail EN 60715  depth 15 mm or on plate with screws Ø4 mm (by removing claws) 4 bars 12 x 4 mm with five connectors 2 x 10 mm ² /bar (not mounted)
1	0 374 30	Fixing on rail EN 60715  , with claws Cat.No 0 374 39 or on plate with M6 screws 4 bars 15 x 4 mm supplied with: - 1 incoming 35 mm ² - M8 screws - 5 outgoing 25 mm ² - M6 screws
1	0 374 31	160 A Fixing on rail EN 60715  , with claws Cat.No 0 374 39 or on plate with M6 screws 4 bars 18 x 4 mm supplied with: - 1 incoming 70 mm ² max. - M8 screws - 5 outgoing 35 mm ² - M6 screws
1	0 374 35	250 A Fixing on rail EN 60715  , with claws Cat.No 0 374 39 or on plate with M6 screws 4 bars 25 x 4 mm supplied with: - 1 incoming 120 mm ² - M10 screws - 5 outgoing 50 mm ² - M8 screws
1	0 373 08	400 A Horizontal mounting in XL ³ 400 cabinets, vertical in XL ³ 400 cable sleeve, vertical in XL ³ 800 internal cable sleeve or on solid plate using the M6 screws supplied Distribution block consisting of 4 tin-coated bars 32 x 5 mm with insulated protection Composition of each bar: - 2 x Ø8.5 mm untapped holes for power supply (flexible bars, ...) - 21 outgoing M6 holes (70 mm ² lugs max.)
1	0 374 42	Fixing on rail EN 60715  , with claws Cat.No 0 374 39 Distribution block consisting of 4 bars 32 x 5 mm Composition of each bar: - 2 x Ø10.5 mm untapped holes for power supply (185 mm ² max.) - 15 outgoing M6 holes, 4 outgoing M8 holes

Modular distribution blocks

40 to 250 A

Conform to EN 60947-1
 Insulating voltage according to EN 60947-1 / IEC 60664-1: 500 V
 Impulse voltage (Uimp): 8 kV - Degree of pollution: 3
 Use in DC: without derating
 Self-extinguishing 960 °C on active parts supports

Monobloc modular distribution blocks

Double pole 40 - 100 - 125 A, Cat.Nos 0 048 81/80/82

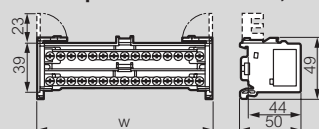

Four pole 40 - 100 - 125 A, Cat.Nos 0 048 85/84/86/88

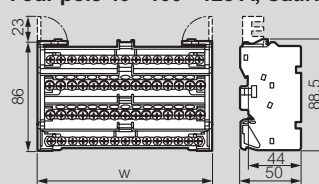

Four pole 125 A Cat.No 0 048 76

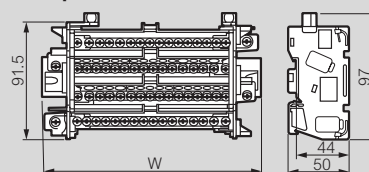

Four pole 160 A, Cat.No 0 048 79

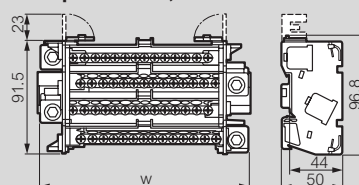

Four pole 250 A, Cat.No 0 048 77

Self-extinguishing 960 °C according to EN 60695-2-11

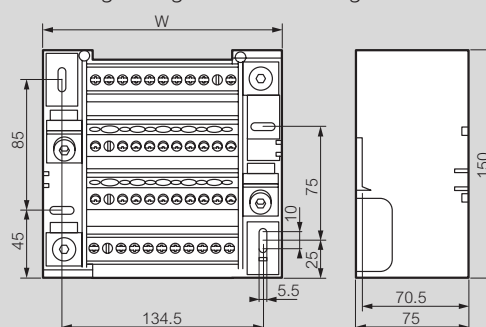

Cat.Nos	Width (mm)
0 048 80	70
0 048 81	105
0 048 82	140
0 048 84	70
0 048 85	105
0 048 86	105
0 048 88	140
0 048 76	179
0 048 77	160
0 048 79	179

Modular distribution blocks

Single pole 125 - 160 - 250 A, Cat.Nos 0 048 71/83/73

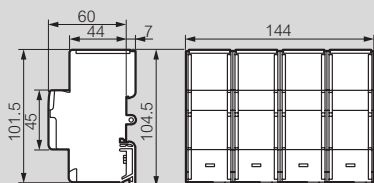

Connection

125 A

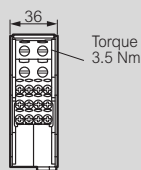

Cat.No 048 71

160 A

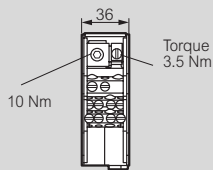

Cat.No 048 83

250 A

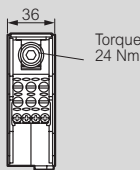

Cat.No 048 73

Distribution terminals, Cat.Nos 0 048 67/68

160 A

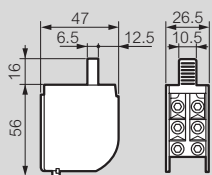

250 A

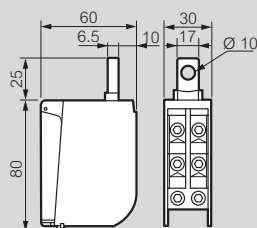

Characteristics of distribution blocks for use in photovoltaic installations

No of 18 mm modules	Cat.No	Max. cross-section for "solar cable"	Max. I _e (A) current T = (+40°C/+60°C) IEC 60364-1	U _i (V) Degree of pollution 2 IEC 60664-1	Impulse voltage U _{imp} IEC 60664-1
Single pole distribution block					
2	0 048 71	4 x 16 to 25 mm ² 12 x 1.5 to 6 mm ² or 6 x 10 mm ²	125/100	1000 V ⁽¹⁾	8 kV ⁽²⁾
Double pole distribution blocks					
4	0 048 80	5 x 1.5 to 6 mm ² 2 x 6 to 16 mm ²	100/80	800 V ⁽¹⁾	8 kV ⁽²⁾
8	0 048 82	11 x 1.5 to 6 mm ² 2 x 6 to 16 mm ² 2 x 10 to 25 mm ²	125/100	800 V ⁽¹⁾	8 kV ⁽²⁾

1: Supplementary insulation provided for the support rail in the context of application of UTE C 15712 double insulation

2: Impulse voltage tested at 12 kV in the context of application of UTE C 15712 double insulation

Section for connecting rigid or flexible conductors (with Starfix ferrules)

Distribution Blocks Cat.Nos	Connections per bar		Rigid conductors Section (mm ²)	Flexible conductors with ferrules	
	Number	Ø (mm)		Section (mm ²)	Starfix ferrules Cat.Nos
0 048 67	6	8.5		6 to 25	0 376 68 to 71
0 048 68	4	10		6 to 35	0 376 68 to 77
	2	8.9		6 to 25	0 376 68 to 71
0 048 71	12	5.3	16 to 50	1.5 to 10	0 376 64 to 69
	4	10	1.5 to 10	16 to 35	0 376 70 to 72 0 376 70 to 77
0 048 73	4	6	70 to 150	2.5 to 10	0 376 66 to 69
	6	8.5	2.5 to 16	10 to 25	0 376 69 to 72
	1	-	10 to 35	70 to 120	-
0 048 80	5	5.3	2.5 to 10	1.5 to 10	0 376 64 to 69
	2	7.5	10 to 25	6 to 16	0 376 68 to 70/72
0 048 81	11	4.3	1.5 to 4	0.75 to 4	0 376 62 to 67
	2	6	6 to 16	4 to 10	0 376 67/68/69
0 048 82	11	5.3	2.5 to 10	1.5 to 10	0 376 64 to 69
	2	7.5	10 to 25	6 to 16	0 376 68 to 70/72
	2	9	10 to 35	10 to 25	0 376 69/72/71
0 048 83	7	5.3	35 to 70	1.5 to 10	0 376 64 to 69
	2	7.5	2.5 to 10	6 to 16	0 376 68/69/72
	3	8.9	6 to 25	10 to 25	0 376 69/72
	1	-	10 to 35	25 to 50	0 376 71 to 71/78
0 048 84	5	5.3	2.5 to 10	1.5 to 10	0 376 64 to 69
	2	7.5	10 to 25	6 to 16	0 376 68 to 70/72
0 048 85	11	4.3	1.5 to 4	0.75 to 4	0 376 62 to 67
	2	6	6 to 16	4 to 10	0 376 67/68/69
0 048 86	7	5.3	2.5 to 10	1.5 to 10	0 376 64 to 69
	2	7.5	10 to 25	6 to 16	0 376 68 to 70/72
	2	9	10 to 35	10 to 25	0 376 69/72
0 048 88	11	5.3	2.5 to 10	1.5 to 10	0 376 64 to 69
	4	8.5	10 to 35	6 to 25	0 376 68 to 71
0 048 79	1	-	35 to 70	35 to 70	0 376 77/78
	8	5.3	2.5 to 10	1.5 to 10	0 376 64 to 69
	4	7.5	10 to 25	6 to 16	0 376 68 to 70/72
	2	8.5	10 to 35	10 to 25	0 376 69/72
0 048 76	14	5.3	2.5 to 10	1.5 to 10	0 376 64 to 69
	1	7.5	10 to 25	6 to 16	0 376 68 to 70/72
	1	8.5	10 to 35	6 to 25	0 376 68 to 70/72
	1	-	-	16 to 35	0 376 70 to 77
0 048 77	6	6	2.5 to 16	2.5 to 10	0 376 66 to 69
	2	7.5	10 to 25	6 to 16	0 376 68 to 70/72
	2	8.5	10 to 35	10 to 25	0 376 69 to 72
	1	10	16 to 50	16 to 35	0 376 70 to 72/77
	1	-	50 to 120	50 to 120	0 376 78

Use of IP 2X terminal blocks

Modular distribution blocks	IP 2X Terminal blocks	Derating	
		Voltage	Rating
0 048 80	0 048 32 ⁽¹⁾	400 V	80 A
0 048 81	0 048 34 ⁽¹⁾	400 V	40 A
0 048 82	0 048 35 ⁽¹⁾	400 V	100 A
0 048 84	0 048 42 ⁽²⁾	400 V	80 A
0 048 85	0 048 44 ⁽²⁾	400 V	40 A
0 048 86	0 048 44 ⁽²⁾	400 V	100 A
0 048 88	0 048 45 ⁽²⁾	400 V	100 A
0 048 76	0 048 46 ⁽²⁾	400 V	100 A
0 048 79	0 048 45 ⁽²⁾	400 V	100 A

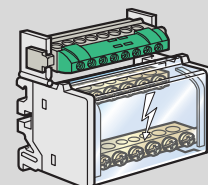

0 048 80 + 0 048 32

1: +
2: Neutral

Power distribution blocks

Extra-flat for lugs

125 A Cat.No 0 374 47 - Isc peak 25 kÅ

Insulating voltage according to EN 60947-1 / IEC 60664-1: 500 V
Self extinguishing: 960 °C according to EN 60695-2-11

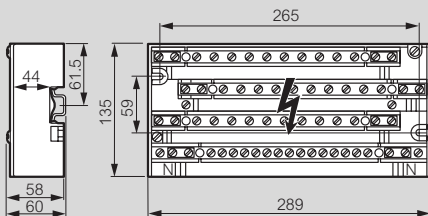

250 A Cat.No 0 374 00 - Isc peak 60 kÅ

Insulating voltage according to EN 60947-1 / IEC 60664-1: 1000 V
Self extinguishing: 960 °C according to EN 60695-2-11

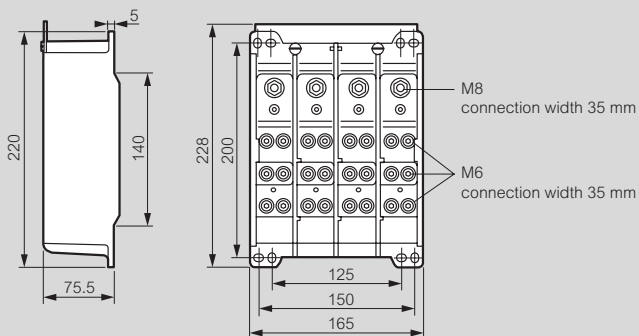

Stepped for lugs

125 A Cat.No 0 373 95 - Isc peak 20 kÅ

Insulating voltage according to EN 60947-1 / IEC 60664-1: 600 V
Self extinguishing: 850 °C according to EN 60695-2-11

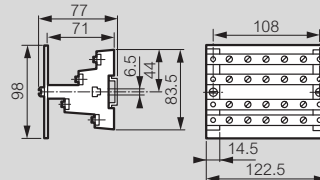

125/160/250 A Cat.Nos 0 374 30/31/35 - Isc peak 35 kÅ

Insulating voltage according to EN 60947-1 / IEC 60664-1: 1000 V
Self extinguishing: 850 °C according to EN 60695-2-11
Uimp: 12 kV, degree of pollution: 3

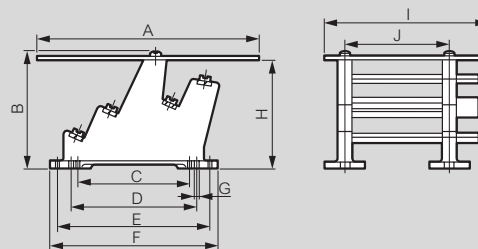

Dimensions (mm)

Distribution blocks	A	B	C	D	E	F	G	H	I	J
125 A	225	125	110	125	165	189	6.5	117.5	165	108
160 A	240	125	110	125	165	189	6.5	117.5	180	120
250 A	260	155	110	125	185	209	6.5	147.5	195	120

400 A⁽¹⁾ Cat.No 0 373 08 - Isc peak 42 kÅ

Insulating voltage according to EN 60947-1 / IEC 60664-1: 1000 V
Uimp: 12 kV, degree of pollution: 3
Self extinguishing: 960 °C according to EN 60695-2-11

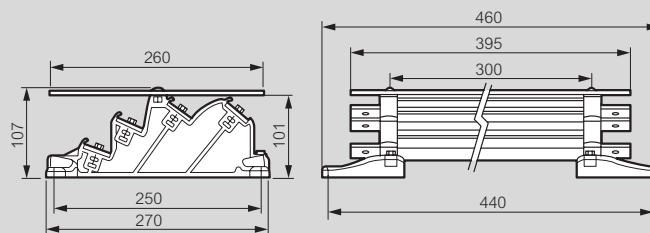

Cat.No 374 42 - Isc peak 50/75 kÅ

Insulating voltage according to EN 60947-1 / IEC 60664-1: 1000 V
fixing centres 50 mm, 1500 V fixing centres 75 mm
Uimp: 8 kV fixing centres 50 mm, 12 kV fixing centres 75 mm
Degree of pollution: 3

1: Horizontal mounting with minimum faceplates height 300 mm

Connection



0 374 05
on copper bar

0 374 80

0 330 74

"Standard" distribution

Pack	Cat.Nos	Connectors															
10	0 374 03	With 3 outgoing terminals 200 A Fits onto flat copper bars and distribution block Cat.No 0 374 00 (p. 22) Capacity: - 1 x Ø5.3 mm outgoing terminal for 1.5 to 6 mm ² connection - 2 x Ø7.5 mm outgoing terminals for 6 to 16 mm ² connection															
4	0 373 99	With 6 outgoing terminals 250 A Fits onto C section aluminium bars with M10 hammer head bolt Cat.No 0 373 59 or onto flat copper bars Capacity: - 4 x 6 to 35 mm ² - 2 x 6 to 25 mm ²															
5	0 374 05	With 7 outgoing terminals 400 A Fits onto flat copper bars Capacity: - 4 x Ø5.3 mm outgoing terminals for 1.5 to 6 mm ² connection - 3 x Ø7.5 mm outgoing terminals for 6 to 16 mm ² connection															
		Aluminium/copper distribution boxes up to 300 mm² Adapt the cross-section of the incoming or outgoing cable in order to connect a device IP 2X box, self-extinguishing transparent cover Universal fixing on 4 rail or on plate Reversible sealable cover with area for label Operational voltage: Ue = 690 V~ according to EN 60947-1/IEC 60664-1 • Aluminium connection Conform to standard NFC 63-061 class B • Copper connection Conform to standard EN 60947-7-1 Supplied with copper coupling strip															
5	0 374 80	Aluminium/copper 120 mm ² distribution box 300 A max. Incoming: 16 to 120 mm ² Aluminium or 16 to 120 mm ² copper Outgoing: 16 to 70 mm ² copper															
4	0 374 81	Aluminium/copper 300 mm ² distribution box 540 A max. Incoming: 70 to 300 mm ² Aluminium or 70 to 185 mm ² copper Outgoing: 70 to 150 mm ² copper															
		Junction boxes IP 30 - IK 07 For copper cables 4 connections per pole Reversible stirrup for zero clamping Fitted with 4 or 5 junction blocks mounted on an insulated strip with a sheet steel cover Knock-out entries for conduits Ø9 and 21 mm Sealable cover screws RAL 7032															
1	0 330 44	<table border="1"> <thead> <tr> <th>Poles</th> <th>Cable section (mm²)</th> <th>Rated current (A)</th> </tr> </thead> <tbody> <tr> <td>4</td> <td>35</td> <td>125</td> </tr> <tr> <td>4</td> <td>70</td> <td>192</td> </tr> <tr> <td>4</td> <td>150</td> <td>309</td> </tr> <tr> <td>4</td> <td>240</td> <td>415</td> </tr> </tbody> </table>	Poles	Cable section (mm ²)	Rated current (A)	4	35	125	4	70	192	4	150	309	4	240	415
Poles	Cable section (mm ²)	Rated current (A)															
4	35	125															
4	70	192															
4	150	309															
4	240	415															

Connection

Connectors

Cat.No 0 374 03

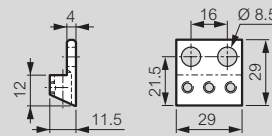

Cat.No 0 374 05

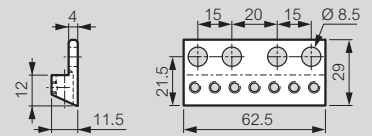

Cat.No 0 373 99

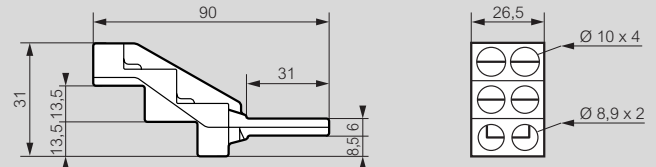

Aluminium/copper distribution boxes

Technical characteristics

	Cat.No 0 374 80	Cat.No 0 374 81
Impulse voltage (Uimp)	10 kV	12 kV
Short-circuit current	14.5 kA	22.2 kA
Icw for 1 second	14 Nm	30 Nm
Tightening torque		

Dimensions

Cat.No 0 374 80

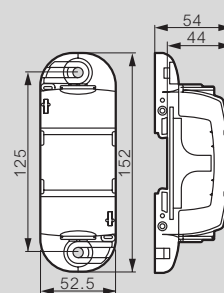

Cat.No 0 374 81

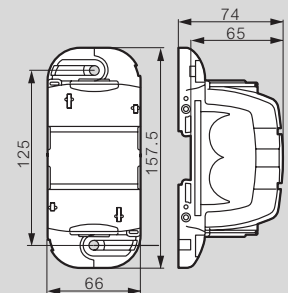

Connection

Junction

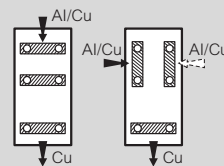

Distribution

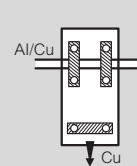

Connecting in series

This bridging is made with 2 copper bars (supplied with each product) and accept max. rating of incoming cable for tap-off between 2 distributions boards

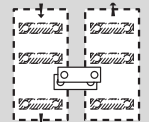

Junction boxes

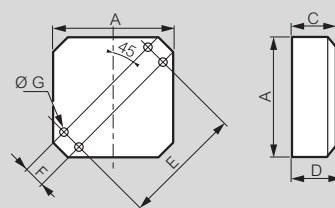

Cat.Nos	A (mm)	C (mm)	D (mm)	E (mm)	F (mm)	G (mm)
0 330 44	236	75	89	264	40	6
0 330 54	176	84	99	314	40	7
0 330 74	319	103	118	361	50	7
0 330 84	510	129	144	613	65	9

Busbars supports selection

standard distribution

Max. In (A)	Flat copper bars					C-section aluminium bars				
	400	800	1000	1600	4000	1600	1600	1600	1600	
Supports										
Mounting	0 373 10	0 373 15	0 373 20	0 373 21	0 373 22/23	0 373 24/25	0 373 66/86/50	0 373 68/51	0 373 67	0 373 69
XL³ 400										
		●								
	●									
XL³ 800										
		● + 0 373 14								
	●									
			●							
XL³ 4000										
	D: 475				● + 0 205 51 ⁽⁵⁾		● ⁽⁵⁾			
	D: 725				● + 0 205 52	● ⁽⁵⁾	● ⁽⁶⁾	● ⁽⁵⁾		
	D: 975				● + 0 205 53	● ⁽¹⁾	● ⁽¹⁾⁽⁷⁾	● ⁽⁷⁾		
	D: 725				● + 0 205 51	● ⁽⁴⁺⁵⁾	●	● ⁽⁵⁾		
	D: 975				● + 0 205 52	●	● ⁽¹⁾	●		
	D: 475		● + 0 205 51	● + 0 205 51	● + 0 205 51		●		●	
	D: 725		● + 0 205 52	● + 0 205 52	● + 0 205 52	●	● ⁽¹⁾	●	● ⁽¹⁾	●
	D: 975		● + 0 205 53	● + 0 205 53	● + 0 205 53	● ⁽¹⁾	● ⁽¹⁾	● ⁽¹⁾	● ⁽¹⁾	● ⁽¹⁾
	D: 725		● + 0 205 51		● + 0 205 51		●			
	D: 975		● + 0 205 52		● + 0 205 52	●	● ⁽¹⁾	●		
	W: 475		● + 0 205 51		● + 0 205 51 ⁽²⁾		●			
	W: 725	● + 0 373 14	● + 0 205 52		● + 0 205 52		●	●		
	W: 975		● + 0 205 53		● + 0 205 53		●	● ⁽¹⁾		
	W: 475		● ⁽³⁾ + 0 205 51		● ⁽³⁾ + 0 205 51	● ⁽³⁾ + 0 205 51				
	W: 725		● ⁽³⁾ + 0 205 52		● ⁽³⁾ + 0 205 52	● ⁽³⁾ + 0 205 52				
	W: 975		● ⁽³⁾ + 0 205 53		● ⁽³⁾ + 0 205 53	● ⁽³⁾ + 0 205 53				

1: With upright Cat.No 0 205 20 in cable sleeve - 2: Depth min. 725 mm - 3: Fixed supports only - 4: Inside complementary cable sleeve - 5: Partial chassis - 6: With crosspieces Cat.No 0 205 52 - 7: With crosspieces Cat.No 0 205 53

Isolating supports for busbars

XL³ cabinets and enclosures



0 373 10



0 373 24

Dimensions **p. 31**
Distances between the supports **p. 28**

"Standard" distribution

Pack Cat.Nos 1 bar per pole universal supports

Pack	Cat.Nos	Description
10	0 373 98	≤ 280 A Single pole support for flat copper bars 12 x 2 or 14 x 4 mm
10	0 374 37	Single pole support for flat copper bars 15 x 4, 18 x 4 or 25 x 4 mm
5	0 373 96	Set of 2 four pole supports for flat copper bars 12 x 2 or 12 x 4 mm
1	0 374 32	Set of 2 four pole supports for flat copper bars 15 x 4 or 18 x 4 mm
1	0 374 36	Set of 2 four pole supports for flat copper bars 25 x 4 mm



1 bar per pole

Pack	Cat.Nos	Description
1	0 373 15	≤ 400 A Support for flat copper bars 18 x 4, 25 x 5 and 32 x 5 mm For XL ³ 400 cabinets and enclosures
1	0 373 10	Support for flat copper bars 18 x 4, 25 x 4, 25 x 5 and 32 x 5 mm, in sloping position to create a vertical busbars at back For direct mounting on solid or perforated plate
1	0 373 20	≤ 800 A Support for flat copper bars 18 x 4, 25 x 5, 32 x 5, 50 x 5 and 63 x 5 mm in sloping position
1	0 373 21	≤ 1000 A Support for flat copper bars 50 x 5, 63 x 5, 75 x 5 and 80 x 5 mm in staggered position

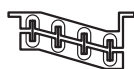

Pack Cat.Nos 1 or 2 bars per pole

Pack	Cat.Nos	Description
		Supports for flat copper bars 50 x 5, 63 x 5, 75 x 5, 80 x 5 and 100 x 5 mm, in aligned position
1	0 373 22	≤ 1600 A Fixed support
1	0 373 23	Additional support Mounted in addition to fixed support Cat.No 0 373 22 to comply with the distances (Isc withstand)



1 to 4 bars per pole

Pack	Cat.Nos	Description
		Supports for 4 flat bars from 50 x 5 to 125 x 5 mm or 3 bars from 50 x 10 to 120 x 10 mm, in aligned position
1	0 373 24	≤ 4000 A Fixed support
1	0 373 25	Additional support Mounted in addition to fixed support Cat.No 0 373 24 to comply with the distances (Isc withstand)



Fixing supports

Pack	Cat.Nos	Description
1	0 205 51	Adjustable crosspieces Set of 2 crosspieces length 350 mm
1	0 205 52	Set of 2 crosspieces length 600 mm
1	0 205 53	Set of 2 crosspieces length 850 mm
1	0 205 31	Crosspieces for partial chassis Set of 2 fixed crosspieces length 350 mm
1	0 205 32	Set of 2 fixed crosspieces length 600 mm

Pack	Cat.Nos	Description
1	0 373 14	Extension piece For mounting busbars supports Cat.No 0 373 15 in XL ³ 800 and 4000 cabinets and enclosures

Isolating supports for busbars

Peak current I_{pk}

The distance between the busbar supports depends on the electrodynamic forces generated when there is a short-circuit, these being directly proportional to the peak value of the short-circuit current (I_{pk})
Two methods can be used to determine the peak current value according to data that is generally available:

Using the limiting capacity of the protective devices

The limitation curves of the protective devices (DX and DPX) give the limited peak current according to the prospective short-circuit current
The "Non-limited peak I_{sc}" curve corresponds to no protection
The table opposite gives the limited peak value (I_{pk}) for a maximum prospective short-circuit value equal to the breaking capacity (I_{cu}) of the device
For lower prospective short-circuit values, reading the curves will provide an optimised value

	Rating (A)	I _{sc} peak Max. (kA)
DPX 125	16-25	11.9
DPX 125	40-63	15
DPX 125	100-125	17
DPX 160	25	14.3
DPX 160	40 to 160	20
DPX 250 ER	100 to 250	22
DPX 250	All	27
DPX-H 250	All	34
DPX 630	All	34
DPX-H 630	All	42
DPX 1600	All	85
DPX-H 1600	All	110

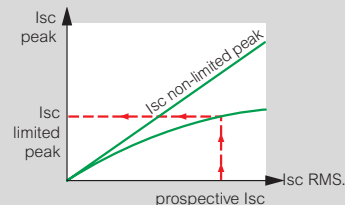

The peak value is much higher if



There are no limiting protective devices
This value is calculated by applying a coefficient of asymmetry (n) to the prospective rms value shown in the table opposite

I _{sc} prospective RMS (kA)	n
≤ 5	1.5
5 < I ≤ 10	1.7
10 < I ≤ 20	2
20 < I ≤ 50	2.1
50 < I	2.2

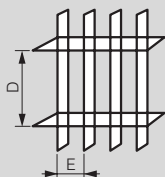

Determining the distances between the supports



Maximum distances "D" (mm) E adjustable

Supports	 0 373 98				 0 374 37			
	Bars 0 373 88 (12 x 2) or 0 373 89 (12 x 4) 0 374 33 (15 x 4) or 0 374 34 (18 x 4) or 0 374 38 (25 x 4)							
E (mm)	50	75	100	125	50	75	100	125
I _{sc} peak (I _{pk} in kA)	10	400	600	800	350	600	750	
	15	300	450	600	800	250	400	700
	20	250	350	450	600	150	225	375
	25	200	250	300	400	125	150	250
	30				100	125	150	175
	35					100	125	150

Maximum distances "D" (mm) E fixed

Supports	 0 373 96				 0 374 32				 0 374 36				
	Bars 0 373 88 (12 x 2) 0 373 89 (12 x 4) 0 374 33/34 (15 x 4) (18 x 4) 0 374 38 (25 x 4) 0 374 34 (18 x 4) 0 374 38 (25 x 4) 0 374 18 (25 x 5) 0 374 19 (32 x 5) 0 374 34 (18 x 4) 0 374 18 (25 x 5) 0 374 19 (32 x 5)												
E (mm)	10	15	20	25	30	35	40	45	50	55	60	70	80
I _{sc} peak (I _{pk} in kA)	10	200	400	550	650	550	650	800	900	1000	1200	1500	
	15	150	300	400	500	400	600	700	800	700	1000	1200	
	20	125	200	300	400	300	450	550	700	550	750	950	
	25	100	150	200	350	250	350	400	500	400	600	750	
	30			150	200	200	300	350	400	350	500	650	
	35			100	150	150	250	300	350	300	400	550	
	40				100	150	200	300	300	250	350	450	
	45						150	200	200	200	300	400	
	50						150	175	100	200	300	400	
	55						100	150	100	200	250	300	
	60							150		200	250	300	
	70									150	200	250	
	80									150	200	250	

Determining the distances between the supports (continued)

Maximum distances "D" (mm) - E fixed: 75 mm

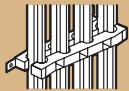
Supports		 0 373 20					 0 373 21			
Bars		1 flat bar per pole					1 flat bar per pole			
		0 374 34 (18 x 4)	0 374 18 (25 x 5)	0 374 19 (32 x 5)	0 374 40 (50 x 5)	0 374 41 (63 x 5)	0 374 40 (50 x 5)	0 374 41 (63 x 5)	0 374 59 (75 x 5)	0 374 43 (80 x 5)
Isc peak (Ipk in kA)	10	800	800	900			1000	1200	1200	1200
	15	400	600	600	700	800	800	900	1000	1000
	20	300	450	500	600	700	650	700	750	750
	25	250	350	400	500	550	500	600	600	600
	30	225	300	350	400	450	400	500	550	550
	35	200	250	300	350	400	350	450	450	450
	40	175	200	250	275	300	300	350	400	400
	45	150	200	200	225	250	300	300	350	350
	50	150	150	150	200	200	250	250	300	300
	60	125	125	125	150	150	200	250	250	250
	70	100	100	100	150	150	150	200	200	200
	80				100	100	100	150	200	200
	90						100	150	200	200
	100						100	150	150	150
110						100	100	150	150	
120						100	100	100	100	

Maximum distances "D" (mm) - E fixed: 75 mm

Supports		 0 373 22, 0 373 23									
Bars		1 flat bar per pole					2 bars per pole				
		0 374 40 (50 x 5)	0 374 41 (63 x 5)	0 374 59 (75 x 5)	0 374 43 (80 x 5)	0 374 46 (100 x 5)	0 374 40 (50 x 5)	0 374 41 (63 x 5)	0 374 59 (75 x 5)	0 374 43 (80 x 5)	0 374 46 (100 x 5)
Isc peak (Ipk in kA)	10	1000	1200	1200	1200	1200					
	15	800	900	1000	1000	1200					
	20	650	700	750	750	900					
	25	500	600	600	600	700					
	30	400	500	550	550	600	700	600			
	35	350	450	450	450	550					
	40	300	350	400	400	450	550	600	650	650	700
	45	300	300	350	350	400					
	50	250	250	300	300	350	450	500	500	500	550
	60	200	250	250	250	300	350	400	400	400	450
	70	150	200	250	250	250	250	350	350	350	400
	80	100	150	200	200	200	250	300	300	300	300
	90	100	150	200	200	200	200	250	300	300	300
	100	100	150	150	150	150	200	200	250	250	250
110	100	100	150	150	150	200	150	200	200	200	
120	100	100	100	100	100	150	150	200	200	200	

Additional support:

- Horizontal busbars⁽¹⁾
- Mounted in addition:
 - to 2 fixed supports in enclosure width 725 et 975
 - to fixed support in cable sleeves width 475
- Vertical busbars
- Mounted in addition to 3 fixed supports if necessary

1: In case of flat bar mounting, use fixed support only

Maximum distances "D" (mm)

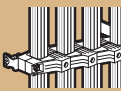
Supports		 0 373 50/66/67/86					 0 373 51/68/69				
Bars		1 C-section aluminium bar per pole					1 C-section aluminium bar per pole				
		0 373 54	0 373 55	0 373 56	0 373 57	0 373 58	0 373 54	0 373 55	0 373 56	0 373 57	0 373 58
Isc peak (Ipk in kA)	30	1600	1600	1600	1600	1600	1600	1600	1600	1600	1600
	40	1000	1000	1000	1000	1000	1000	1000	1000	1000	1000
	52	800	800	800	800	800	800	800	800	800	800
	63	700	700	700	700	700	600	600	600	600	600
	73	600	600	600	600	600	500	500	500	500	500
	80	600	600	600	600	600	500	500	500	500	500
	94	500	500	500	500	500	400	400	400	400	400
	105	500	500	500	500	500	400	400	400	400	400
	132	-	-	500	500	500	-	-	400	400	400
	154	-	-	400	400	400	-	-	300	300	300

Dimensions

Cat.No 0 373 98

Side for 12 x 2 mm bar

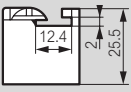

Side for 12 x 4 mm bar

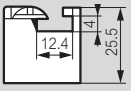

View from above

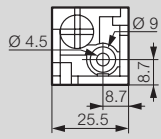

Cat.No 0 374 37

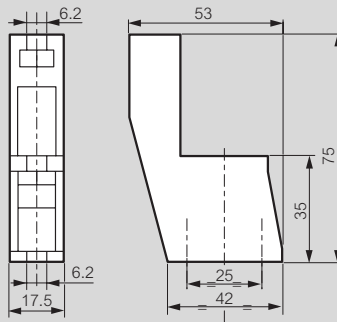

Cat.No 0 373 96

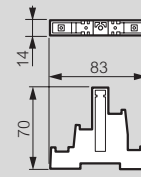

Cat.No 0 374 32

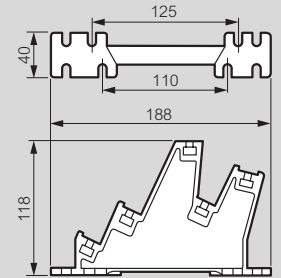

Cat.No 0 374 36

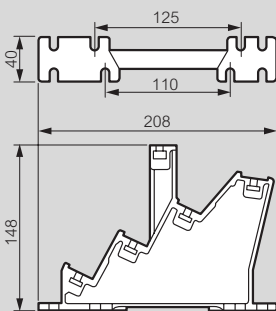

Cat.No 0 373 15

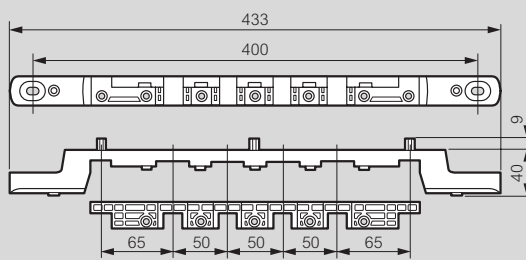

Cat.No 0 373 10

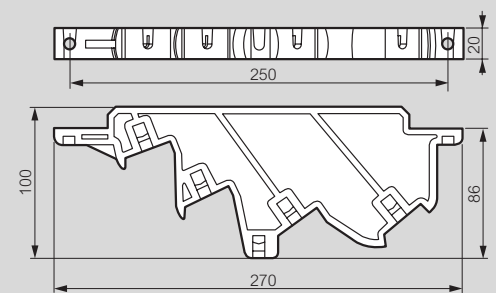

Cat.No 0 373 20

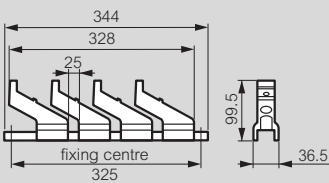

Cat.No 0 373 21

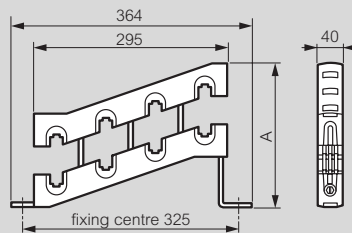

Dim. (mm)	Copper bar			
	50 x 5	63 x 5	75 x 5	80 x 5
A	217	230	242	247

Cat.No 0 373 22 (fixed support)

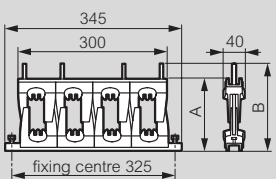

Cat.No 0 373 23 (additional support)

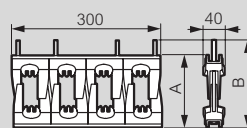

Dim. (mm)	Copper bar				
	50 x 5	63 x 5	75 x 5	80 x 5	100 x 5
A	112	125	137	142	162
B	126	126	171	171	171

Cat.No 0 373 24 (fixed support)

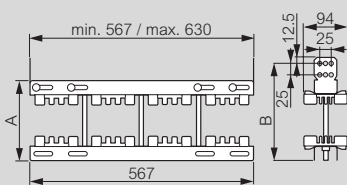

Cat.No 0 373 25 (additional support)

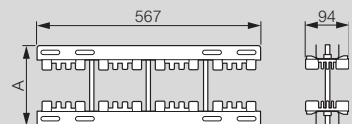

Cat.Nos	Dim. (mm)	Bars thick 5 or 10 mm				
		h75	h80	h100	h120	h125
0 373 24	A	151	156	176	196	201
	B	187.5	192.5	215.5	232.5	237.5
0 373 25	A	151	156	176	196	201

Cat.Nos 0 373 50/51/66/69

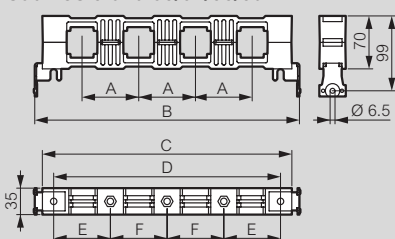

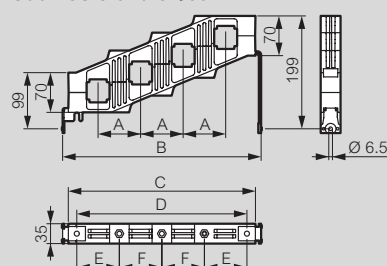

Cat.Nos 0 373 67/69



Cat.Nos	A	B	C	D	E	F
0 373 66	75	350	330	300	75	75
0 373 68	125	600	580	550	150	125
0 373 67	75	350	330	300	75	75
0 373 69	125	600	580	550	150	125
0 373 50	75	-	330	300	75	75
0 373 51	125	-	580	550	150	125

Flat copper bars selection

standard distribution

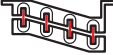
			≤ 400 A				≤ 800 A		≤ 1000 A	
Flat busbars supports			 Cat.No 0 373 10		 Cat.No 0 373 15		 Cat.No 0 373 20		 Cat.No 0 373 21	
Flat copper bars										
Cat.Nos	Cross Section (mm)	Number of bar per pole	I (A)		I (A)		I (A)		I (A)	
			IP ≤ 30	IP > 30	IP ≤ 30	IP > 30	IP ≤ 30	IP > 30	IP ≤ 30	IP > 30
0 374 34	18 x 4	1	245	200	245	200	245	200	-	-
0 374 38	25 x 4	1	280	250	-	-	-	-	-	-
0 374 18	25 x 5	1	330	270	330	270	330	270	-	-
0 374 19	32 x 5	1	450	400	450	400	450	400	-	-
0 374 40	50 x 5	1	-	-	-	-	700	630	700	630
		2	-	-	-	-	-	-	-	-
		3	-	-	-	-	-	-	-	-
		4	-	-	-	-	-	-	-	-
0 374 41	63 x 5	1	-	-	-	-	800	700	800	700
		2	-	-	-	-	-	-	-	-
		3	-	-	-	-	-	-	-	-
		4	-	-	-	-	-	-	-	-
0 374 59	75 x 5	1	-	-	-	-	-	-	950	850
		2	-	-	-	-	-	-	-	-
		3	-	-	-	-	-	-	-	-
		4	-	-	-	-	-	-	-	-
0 374 43	80 x 5	1	-	-	-	-	-	-	1050	900
		2	-	-	-	-	-	-	-	-
		3	-	-	-	-	-	-	-	-
		4	-	-	-	-	-	-	-	-
0 374 46	100 x 5	1	-	-	-	-	-	-	-	-
		2	-	-	-	-	-	-	-	-
		3	-	-	-	-	-	-	-	-
		4	-	-	-	-	-	-	-	-
	125 x 5	1	-	-	-	-	-	-	-	-
		2	-	-	-	-	-	-	-	-
		3	-	-	-	-	-	-	-	-
		4	-	-	-	-	-	-	-	-
	80 x 10	1	-	-	-	-	-	-	-	-
		2	-	-	-	-	-	-	-	-
		3	-	-	-	-	-	-	-	-
	100 x 10	1	-	-	-	-	-	-	-	-
2		-	-	-	-	-	-	-	-	
3		-	-	-	-	-	-	-	-	
120 x 10	1	-	-	-	-	-	-	-	-	
	2	-	-	-	-	-	-	-	-	
	3	-	-	-	-	-	-	-	-	

Copper bars and accessories

≤ 1600 A				≤ 4000 A			
Cat.Nos 0.373 22/23 bar mounting: edgewise		bar mounting: flat		Cat.Nos 0.373 24/25 bar mounting: edgewise		bar mounting: flat	
I (A)		I (A)		I (A)		I (A)	
IP ≤ 30	IP > 30	IP ≤ 30	IP > 30	IP ≤ 30	IP > 30	IP ≤ 30	IP > 30
-	-	-	-	-	-	-	-
-	-	-	-	-	-	-	-
-	-	-	-	-	-	-	-
-	-	-	-	-	-	-	-
700	630	430	350	700	630	500	420
1150	1000	650	510	1180	1020	750	630
-	-	-	-	1600	1380	1000	900
-	-	-	-	2020	1720	1120	1000
800	700	500	400	800	700	600	500
1350	1150	770	590	1380	1180	750	630
-	-	-	-	1900	1600	1100	1000
-	-	-	-	2350	1950	1350	1200
950	850	600	475	950	850	700	600
1500	1300	890	700	1600	1400	1000	850
-	-	-	-	2200	1900	1250	1100
-	-	-	-	2700	2300	1600	1400
1000	900	630	500	1000	900	750	630
1650	1450	940	740	1700	1480	1050	900
-	-	-	-	2350	2000	1300	1150
-	-	-	-	2850	2400	1650	1450
1250	1050	750	580	1250	1050	850	700
1900	1600	1120	900	2050	1800	1200	1050
-	-	-	-	2900	2450	1600	1400
-	-	-	-	3500	2900	1900	1650
-	-	-	-	1450	1270	1000	800
-	-	-	-	2500	2150	1450	1250
-	-	-	-	3450	2900	1800	1600
-	-	-	-	4150	3450	2150	1950
-	-	-	-	1460	1270	1150	950
-	-	-	-	2500	2150	1700	1500
-	-	-	-	3450	2900	2500	2000
-	-	-	-	1750	1500	1350	1150
-	-	-	-	3050	2550	2000	1650
-	-	-	-	4150	3500	2900	2400
-	-	-	-	2000	1750	1650	1450
-	-	-	-	3600	2950	2500	2000
-	-	-	-	4800	4000	3500	3000



0 374 19 + 0 373 11

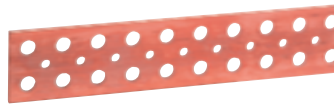

0 374 40





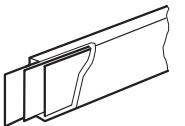
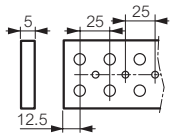
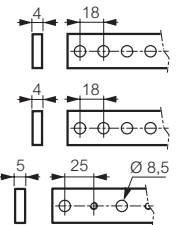

0 374 10

"Standard" distribution

Pack	Cat.Nos	Copper bars				
Rigid, flat, threaded holes						
		Cross section (mm)	I permissible(A)		Holes Ø mm	Length (mm)
			IP ≤ 30	IP > 30		
10	0 373 88	12 x 2	110	80	M5	990
10	0 373 89	12 x 4	160	125	M5	990
10	0 374 33	15 x 4	200	160	M5	990
10	0 374 34	18 x 4	245	200	M6	990
10	0 374 38	25 x 4	280	250	M6	990
4	0 374 18	25 x 5	330	270	M6	1750
4	0 374 19	32 x 5	450	400	M6	1750
Rigid flat clear holes						
		Cross section (mm)	I permissible(A)		Holes Ø mm	Length (mm)
			IP ≤ 30	IP > 30		
1	0 374 40	50 x 5	700	630	10.5 - 6.5	1750
1	0 374 41	63 x 5	800	700	10.5 - 8.5	1750
1	0 374 59	75 x 5	950	850	10.5 - 6.5	1750
1	0 374 43	80 x 5	1000	900	10.5 - 6.5	1750
1	0 374 46	100 x 5	1250	1050	10.5 - 6.5	1750
Flexible						
Supplied flat, length 2 m						
		Cross section (mm)	I (A)			
			IP ≤ 30	IP > 30		
1	0 374 10	13 x 3	200	160		
1	0 374 67	20 x 5	400	250		
1	0 374 11	24 x 4	400	250		
1	0 374 12	32 x 5	630	400		
1	0 374 57	50 x 5	850	630		
1	0 374 58	50 x 10	1250	1000		
Accessories						
1/10	0 373 11	Isolating profile Isolating profile for flat copper bars 18 x 4, 25 x 4, 25 x 5 and 32 x 5 mm, length 1 m Supplied with fixing clips				
50	0 367 74	Insulating screws M6 x 10				
50	0 367 75	HF screws with contact washer M6 x 10				

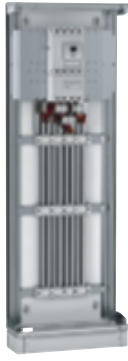
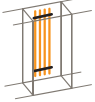
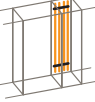
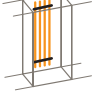
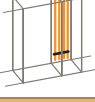
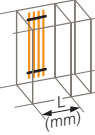
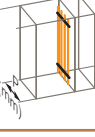
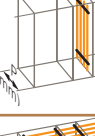

VX³ optimised distribution system selection





VX ³ distribution system	I _{max} (A)	Mounting	Cat.Nos	Plexo ³ XL ³ 125 XL ³ 160	XL ³ 400	XL ³ 800	XL ³ 4000	
VX ³ 4-pole automatic terminals vertical distribution block (p. 36)	63 A	 side-mounted	For cabinets with 3 rows: 4 050 23 4 rows: 4 050 24 5 rows: 4 050 25 6 rows: 4 050 26	●				
	125 A	 side-mounted	For cabinets with 4 rows: 4 050 34 5 rows: 4 050 35 6 rows: 4 050 36	● ⁽¹⁾	●			
	400 A (p. 40)	 Vertical at back of enclosure	Insulated backplate: 4 044 36 Support: 4 044 37 Supp. for lug: 4 044 38 250 A bar: 4 044 30 400 A bar: 4 044 31		●			
		 Vertical in cable sleeve	Support: 4 044 50 Supp. for lug: 4 044 51 250 A bar: 4 044 30 400 A bar: 4 044 31		●			
	800 A (p. 41)	 Vertical at back of enclosure	Support: 4 044 60 Supp. for lug: 4 044 61 800 A bar: 4 044 33			●	●	
		 Vertical in external cable sleeve	Support: 4 044 70 Supp. for lug: 4 044 71 800 A bar: 4 044 33			●		
VX ³ busbars	XL³ 4000							
	630 A bar: 0 373 54 800 A bar: 0 373 55 1000 A bar: 0 373 56 1250 A bar: 0 373 57 1600 A bar: 0 373 58		Positions of bars		Aligned		Stepped:	
			Fixing centres of bars		75 mm	125 mm	75 mm	125 mm
			Fixed support		0 373 66/86	0 373 68	0 373 67	0 373 69
			Additional support		0 373 50	0 373 51	-	-
	 vertical en fond d'armoire	L: 475 mm		●				
		L: 725 mm		●	●			
		L: 975 mm		●	●			
	 Side-mounted vertical in enclosure behind uprights	D: 475 mm						
		D: 725 mm		● ⁽²⁾	●			
		D: 975 mm		● ⁽²⁾	●			
	 Vertical in cable sleeve*	D: 475 mm		● ⁽²⁾		●		
		D: 725 mm		● ⁽²⁾	●	●	●	
		D: 975 mm		● ⁽²⁾⁽³⁾	● ⁽³⁾	● ⁽³⁾	● ⁽³⁾	
 Horizontal top or bottom	D: 475 mm		● ⁽²⁾					
	D: 725 mm		● ⁽²⁾	●				
	D: 975 mm		● ⁽²⁾	●				
 Horizontal transfer	D: 475 mm							
	D: 725 mm		● ⁽²⁾	●				
	D: 975 mm		● ⁽²⁾	●				

1: XL³ 160 only

2: Only these configurations take the VX³ optimised prefabricated connection kits

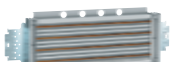

3: With upright Cat.Nos 0 205 20/51

HX³ optimised distribution system selection

HX ³ distribution system		I _{max}	Cat.Nos	Enclosures					
				Ekinoxe	XL ³ 125 Plexo ³	XL ³ 160	XL ³ 400	XL ³ 800	XL ³ 4000
HX ³ universal single pole prong-type busbar (p. 19)		63 A	4 049 26 (13 modules)	●	●	●	●	●	●
			4 049 37 (57 modules)						
HX ³ 4-pole prong-type busbar (p. 19)		63 A	4 052 00 (6 modules)	●	●	●	●	●	●
			4 052 01 (12 modules)						
			4 052 02 (18 modules)						
HX ³ 4-pole automatic terminals distribution block (p. 37)		125 A	4 052 30 (1 row)		● (1/2 row)	●	●	●	●
			4 052 31 (1/2 row)						
HX ³ 4-pole plug-in distribution blocks (p. 38)		80 A	4 052 40 (24 modules)			●	●	●	●
		125 A	4 052 41 ⁽¹⁾ (36 modules)						
			4 052 41 ⁽¹⁾ (36 modules)						
HX ³ 4-pole row distribution blocks (p. 39)		250 A	4 044 80 ⁽²⁾ (24 modules)				●		
		400 A	4 044 81 ⁽²⁾ (24 modules)						
			4 044 83 ⁽²⁾ (24 modules)						
			4 044 84 ⁽²⁾ (24 modules)					●	●

1: With 125 A power supply module Cat.No 4 052 42 - 2: With direct connection, power supply via busbar at back of enclosure
3: Without connection, power supply via head of row device or side-mounted power supply module Cat.No 4 044 82

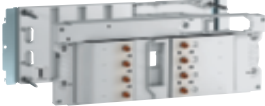
HX³/VX³ IS increased safety distribution system selection

Mounting in XL ³ 4000 enclosures			IS 223	IS 233	IS 333	
VX ³ IS column chassis (p. 48)		Uprights, isolating supports, form 4b partitioning	For depth 725 mm	4 046 00	4 046 00	4 046 00
			For depth 975 mm	4 046 02	4 046 02	4 046 02
		Tinned copper aluminium busbars	1250 A	4 046 04	4 046 04	4 046 04
			2000 A	4 046 06	4 046 06	4 046 06
VX ³ IS bases for devices (p. 48)		DPX ³ 160	3P	4 046 10	4 046 20	4 046 40
			4P	4 046 11	4 046 21	4 046 41
		DPX ³ 160 with e.l.c.bs	4P	4 046 11	4 046 31	4 046 51
			DPX ³ 250	3P	4 046 12	4 046 22
		4P		4 046 13	4 046 23	4 046 43
		DPX ³ 250 with e.l.c.bs	4P	4 046 13	4 046 33	4 046 53
			DPX 630	3P	4 046 16	4 046 26
		4P		4 046 17	4 046 27	4 046 47
		DPX 630 with with e.l.c.bs	3P	4 046 16	4 046 36	4 046 56
			4P	4 046 17	4 046 37	4 046 57
4-pole row distribution blocks (p. 46-47)		HX ³ 125 A IS (connection modules: see p. 46)		4 046 68	-	-
		HX ³ 400 A IS (support bases: see p. 47)		4 046 60	-	-

VX³ 63 and 125 A automatic terminals vertical distribution blocks - 4-pole

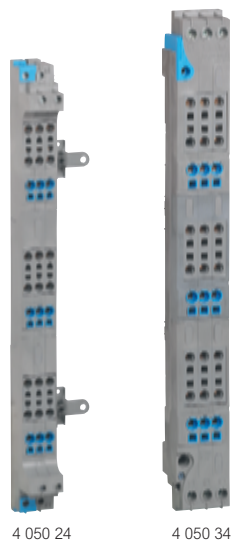

Technical characteristics **see opposite**

IP XXB 4-pole distribution block with automatic output terminals
 For distribution using flexible wires with or without ferrules
 Power supply via the top or bottom, via screw terminals
 Supplied with blanking plates for unused supply terminals and fixing lugs for side-mounting in different enclosures
 Connection/disconnection operations only with power off

Pack	Cat.Nos	VX³ 63 A automatic terminals vertical distribution blocks
		For side-mounting in Plexo ³ , XL ³ 125 and XL ³ 160 cabinets - Fixing lugs on rack for adjusting the vertical position Terminals capacity: - Incoming lines (power supply): 6 to 16 mm ² (flexible)/25 mm ² (rigid) - Outgoing lines: 4 to 10 mm ² (flexible)
2	4 050 23	For cabinets with 3 rows Phase: 3 x 4 outgoing lines Neutral: 6 outgoing lines
2	4 050 24	For cabinets with 4 rows Phase: 3 x 6 outgoing lines Neutral: 9 outgoing lines
2	4 050 25	For cabinets with 5 rows Phase: 3 x 8 outgoing lines Neutral: 12 outgoing lines
2	4 050 26	For cabinets with 6 rows Phase: 3 x 10 outgoing lines Neutral: 15 outgoing lines

Pack	Cat.Nos	VX³ 125 A automatic terminals vertical distribution blocks
		For side-mounting in XL ³ 125 and XL ³ 160 cabinets Terminals capacity: - Incoming lines (power supply): 16 to 35 mm ² (flexible)/50 mm ² (rigid) - Outgoing lines: 6 to 16 mm ² (flexible)
1	4 050 34	For cabinets with 4 rows Phase: 3 x 6 outgoing lines Neutral: 9 outgoing lines
1	4 050 35	For cabinets with 5 rows Phase: 3 x 8 outgoing lines Neutral: 12 outgoing lines
1	4 050 36	For cabinets with 6 rows Phase: 3 x 10 outgoing lines Neutral: 15 outgoing lines

VX³ 63 and 125 A automatic terminals vertical distribution blocks - 4-pole

Technical characteristics

Rated voltage (U_e): 230/400 V_~
 Rated frequency: 50/60 Hz
 Permissible short-circuit current (I_{pk}):
 - VX³ 63 A automatic terminals: 20 kA
 - VX³ 125 A automatic terminals: 30 kA
 Insulation voltage (U_i): 500 V_~
 Protection index: IP XXB

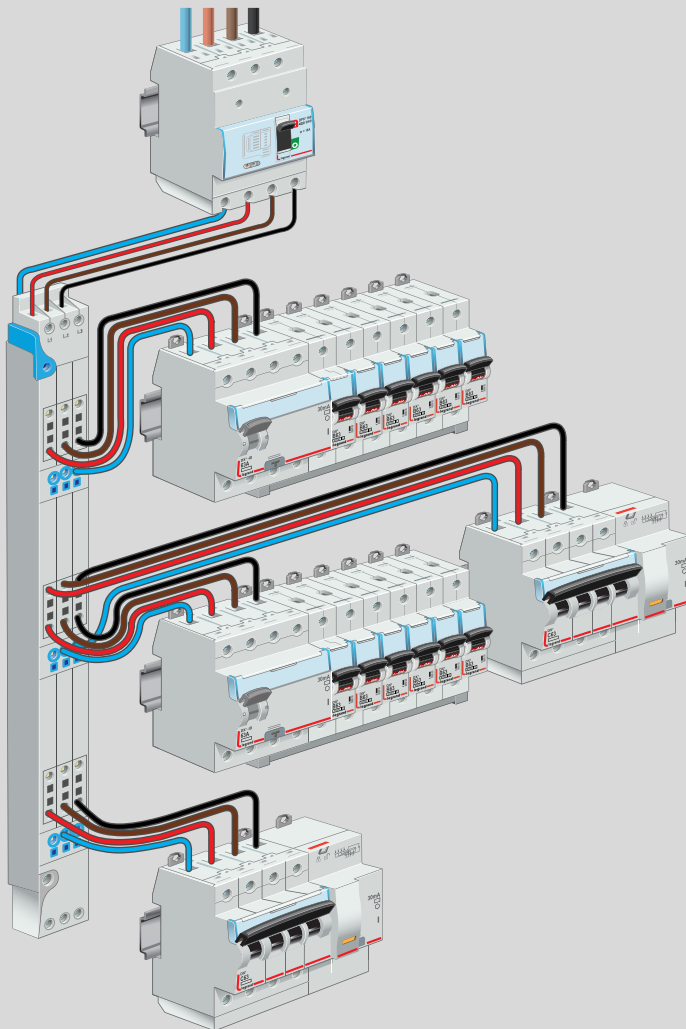

Dimensions

VX³ 63 A

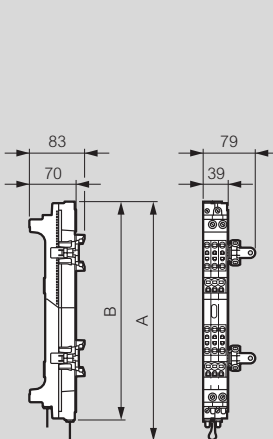

VX³ 125 A

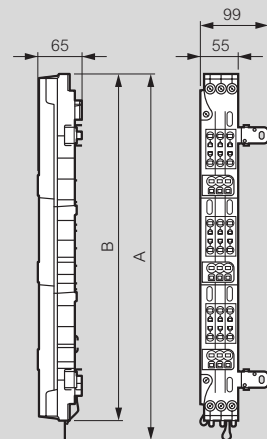

	4 050 23	4 050 24	4 050 25	4 050 26	4 050 34	4 050 35	4 050 36
A	336	461	586	711	506	631	756
B	324	449	574	699	478	603	728

HX³ 125 A automatic terminals horizontal distribution blocks - 4-pole

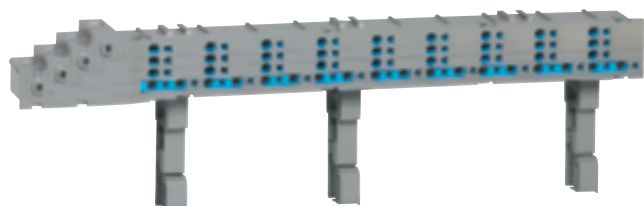

4 052 30

Technical characteristics **see opposite**

IP XXB 4-pole distribution blocks equipped with automatic terminals
For distribution in rows using flexible wires with or without ferrules or rigid wires

Power supply via the top, bottom or feedthrough via screw terminals

Supplied with fixing lugs for mounting on 3 rails in Plexo³ cabinets,

XL³ 125, XL³ 160 and XL³ 400 enclosures and brackets for wire

management

Can be fitted on a solid plate

Pack	Cat.Nos	HX ³ 125 A automatic terminals horizontal distribution blocks
1	4 052 30	Terminals capacity: - Incoming lines (power supply): 10 to 35 mm ² (rigid or flexible) limited to 25 mm ² with feedthrough power supply - Outgoing lines: 0.5 to 6 mm ² For complete row For mounting in XL ³ 160/400/800/4000 enclosures Phase: 3 x 9 outgoing lines Neutral: 18 outgoing lines
1	4 052 31	For 1/2 row For mounting in Plexo ³ cabinets and XL ³ 125/160/400/800/4000 enclosures Phase: 3 x 4 outgoing lines Neutral: 8 outgoing lines

HX³ 125 A automatic terminals horizontal distribution blocks - 4-pole

Technical characteristics

Rated voltage (U_e): 230/400 V \sim

Rated frequency: 50/60 Hz

Permissible short-circuit current (I_{pk}): 20 kA

Insulation voltage (U_i): 500 V \sim

Impulse voltage U_{imp}: 6 kV - degree of pollution 3

Rated current: 125 A

Protection index: IP XXB

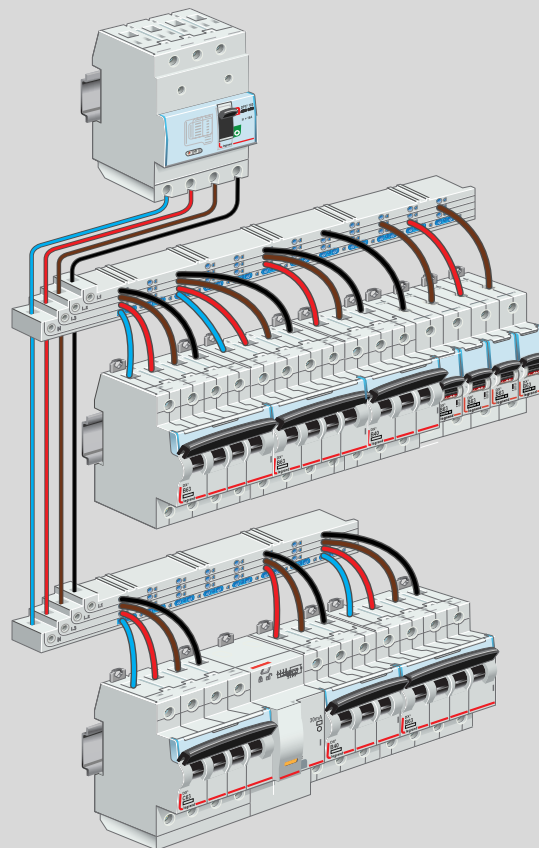

Dimensions

Cat.No 4 052 30

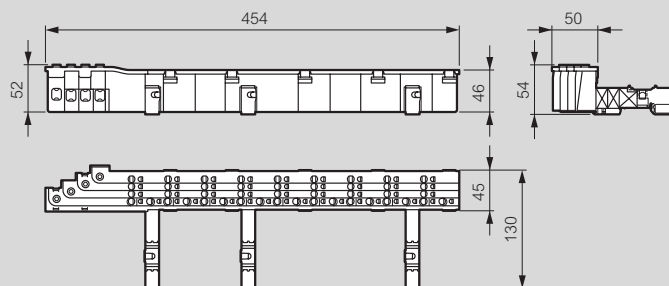

Cat.No 4 052 31

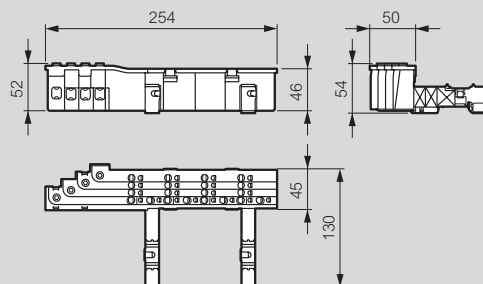

HX³ 80/125 A plug-in system horizontal distribution blocks - 4-pole

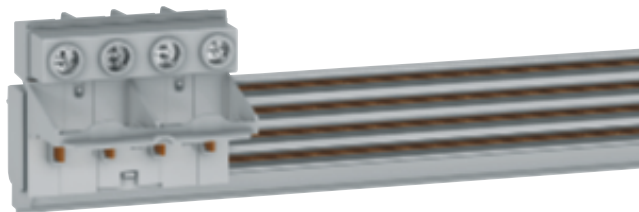

4 052 40 + 4 052 42



4 052 43 4 052 44 4 052 45 4 052 46

Technical characteristics **see opposite**

Used for 3-phase distribution without wiring of DX/DX³ modular devices up to 125 A on a single row

Automatic connection and disconnection of equipment totally safely, thanks to the distribution block's IP XXB insulation
Protection devices can be added or removed even when HX³ 80/125 distribution block is powered-up, thanks to the integral connection modules

Power supply module and head of row device can be removed only after cutting off the power of HX³ distribution block
Total freedom to install and combine devices: 1P+N, 2P, 3P, 4P, add-on modules modules, auxiliaries, control devices, etc
Selection of the phase to be connected by selecting the connection module

For mounting in XL³ 400/800/4000 enclosures with 2-position aluminium rail Cat.Nos 0 202 01 and 0 206 01/51 and in XL³ 160 enclosures with the mounting accessory Cat.No 4 052 24

Pack	Cat.Nos	HX ³ 80/125 A plug-in system horizontal distribution blocks
		Distribution blocks
		Fixed directly onto rails Cat.Nos 0 202 06, 0 206 01 and 0 206 51
		Maximum rated current:
		- 80 A when supplied via head of row device
		- 125 A when equipped with power supply module Cat.No 4 052 42
1	4 052 40	24 modules
1	4 052 41	36 modules
1	4 052 42	125 A power supply module Power supply module and protection cover
		Connection modules
		Used for automatic connection and disconnection of modular devices on the HX ³ 80/125 A plug-in distribution block
		For 1 module per pole devices
1	4 052 43	Pack of 10 connection modules L1
1	4 052 44	Pack of 10 connection modules L2
1	4 052 45	Pack of 10 connection modules L3
1	4 052 46	Pack of 10 connection modules N
1	4 052 24	Accessory for mounting in XL³ 160 enclosure Used for mounting the 24 modules HX ³ 125 A plug-in distribution block Cat.No 4 052 20 in XL ³ 160 enclosures

HX³ 80/125 A plug-in system horizontal distribution blocks - 4-pole

Technical characteristics

Rated voltage (U_e): 230/400 V~
Rated frequency: 50/60 Hz
Permissible short-circuit current (I_{pk}): 25 kA
Insulation voltage (U_i): 690 V~
Maximum rated current:
- 125 A when equipped with power supply module Cat.No 4 052 42
- 80 A when supplied via head of row device
Protection index: IP 20
Maximum connection cross-section for the power supply module: 50 mm²

Compatible DX ³ modular devices	Connection modules
1P+N RCBOs for protecting the outgoing lines	4 052 43/44/45/46 (L1, L2, L3, N)
2P RCCBs for protecting the outgoing lines	
4P RCCBs for protecting the outgoing lines	
4P RCBOs for protecting the outgoing lines	
2P RCBOs for protecting the outgoing lines	
1P, 2P, 3P, 4P circuit breakers, 1 module/pole ⁽¹⁾	

1: Except for products dedicated to the HX³ 4-pole supply busbar

Installation

Direct power supply via the power supply module (for protecting the outgoing lines) - maximum rated current 125 A

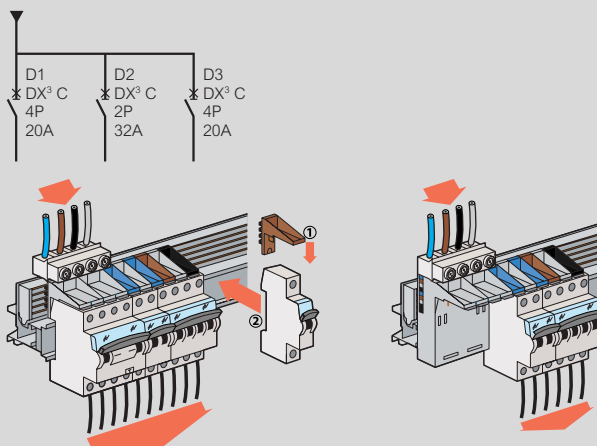

Indirect power supply via head of row device - maximum rated current 80 A

The distribution block is protected by the head of group device and its rated current is limited by the latter's rating

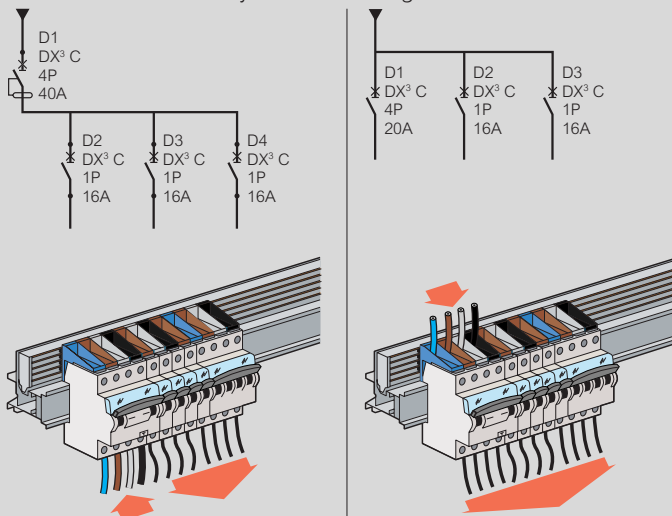

HX³ 400 A optimised distribution system

horizontal mounting in XL³ 400, XL³ 800 and XL³ 4000 enclosures

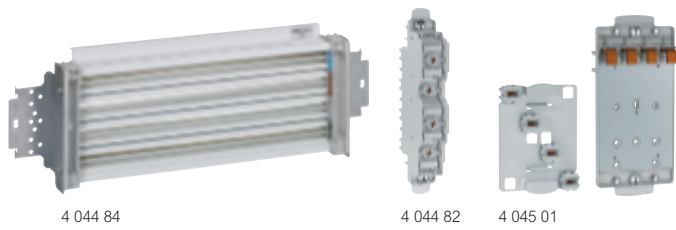

Pack	Cat.Nos	HX ³ 250 A row distribution block
1	4 044 80	For mounting in XL ³ 400 enclosures Take bases for DPX ³ and bases for DX ³ devices Capacity 24 modules With direct connection on VX ³ 250/400 A busbars at back of enclosure
1	4 044 81	Without connections
1	4 044 82	Side-mounting power supply module for distribution block without connections for 250 and 400 A distribution block

Pack	Cat.Nos	HX ³ 400 A row distribution block
1	4 044 83	For mounting in XL ³ 800 and XL ³ 4000 enclosures Take the support bases for DPX ³ and for modular devices Capacity 24 modules With direct connection on VX ³ 800 A busbars at back of enclosure
1	4 044 84	Without connections
1	4 044 82	Side-mounting power supply module for distribution block without connections for 250 and 400 A distribution block

Pack	Cat.Nos	HX ³ support bases for DPX ³ MCCBs
1	4 045 00	For automatic connection of DPX ³ MCCBs on HX ³ 250 A and 400 A row distribution blocks Supplied with terminal shields

Pack	Cat.Nos	For DPX ³ 160
1	4 045 00	3P
1	4 045 01	4P with or without e.l.c.bs

Pack	Cat.Nos	For DPX ³ 250
1	4 045 02	3P
1	4 045 03	4P with or without e.l.c.bs

Pack	Cat.Nos	HX ³ support bases for DX ³ modular devices
1	4 045 08	For automatic connection of DX ³ devices on HX ³ 250 and 400 A row distribution blocks The bases are supplied via the distribution block

Pack	Cat.Nos	Plug-in bases for 1 module per pole DX ³
1	4 045 08	For 4-pole DX ³
1	4 045 09	For 3-pole DX ³
1	4 045 10	For single pole DX ³ - Phase L1
1	4 045 11	For single pole DX ³ - Phase L2
1	4 045 12	For single pole DX ³ - Phase L3
1	4 045 13	For single pole DX ³ - Neutral N

Pack	Cat.Nos	Wired bases for 1.5 module per pole DX ³
1	4 045 15	For 4-pole DX ³
1	4 045 16	For 3-pole DX ³
1	4 045 17	For single pole DX ³ - Neutral N
1	4 045 18	For single pole DX ³ - Phase L1
1	4 045 19	For single pole DX ³ - Phase L2
1	4 045 20	For single pole DX ³ - Phase L3

Pack	Cat.Nos	Wired bases for 1 module per pole DX ³ - In ≤ 63 A
1	4 045 21	For 4-pole DX ³
1	4 045 22	For 3-pole DX ³
1	4 045 23	For single pole DX ³ - Neutral N
1	4 045 24	For single pole DX ³ - Phase L1
1	4 045 25	For single pole DX ³ - Phase L2
1	4 045 26	For single pole DX ³ - Phase L3

Pack	Cat.Nos	Universal base
1	4 045 27	Empty base, 1 module without power supply

HX³ 400 A optimised distribution system

horizontal mounting in XL³ 400, XL³ 800 and XL³ 4000 enclosures

Technical characteristics

Rated voltage (Ue): 230/400 V~
 Rated frequency: 50/60 Hz
 Permissible short circuit current (Ipk): xx kA
 Insulation voltage (Ui): 1000 V
 Rated current: 250/400 A maximum (central power supply)
 Protection index: IP 20
 Maximum connection cross-section for the power supply module:
 flexible bars 32 x 4 mm

Installation

Direct power supply
 Via busbars at back of enclosure

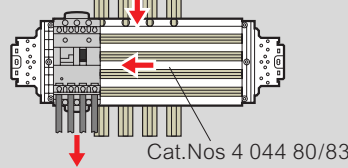

Indirect power supply
 Via head of row device

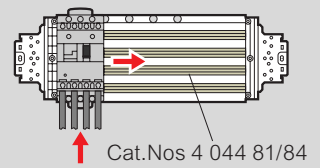

Via busbars in cable sleeve

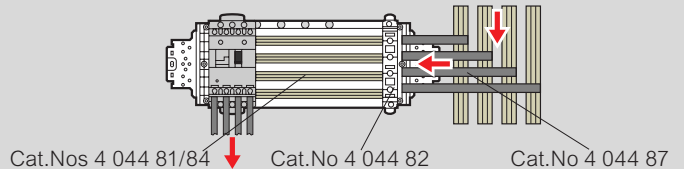

Dimensions

Cat.Nos 4 044 80/81/83/84

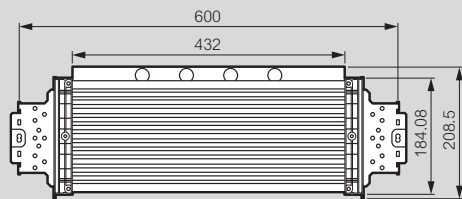

Cat.Nos	A	B
4 044 80/81	515	208.5
4 044 83/84	600	202

Cat.Nos 4 044 82/85

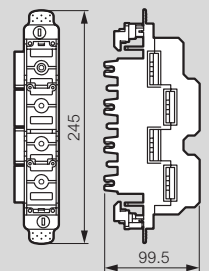

Cat.Nos 4 045 00/01/02/03

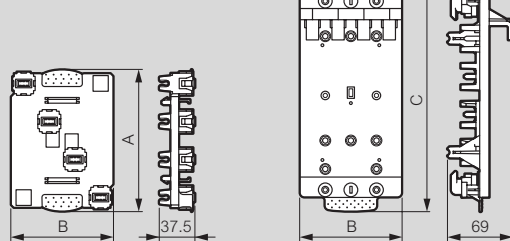

Cat.Nos	A	B	C
4 045 00	150	108	245
4 045 01	150	108	245
4 045 02	150	139,5	266,5
4 045 03	150	139,5	266,5

Bases for DX³

"Plug-in"

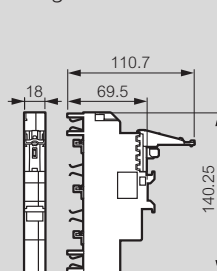

"Wired"

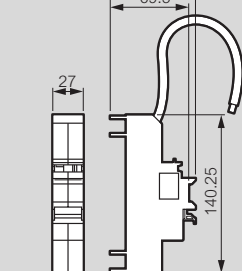

VX³ 400 A optimised distribution system

vertical mounting in XL³ 400 enclosures



C-section bars Cat.No 4 044 30 + supports Cat.No 4 044 50 + connection kit Cat.No 4 044 54

Technical characteristics **see opposite**

Pack	Cat.Nos	VX³ 250/400 A optimised distribution system of aluminium busbars
1	4 044 35	Complete kit Complete kit containing: 1 XL ³ 400 enclosure height 1900 mm + 1 insulated backplate + 3 isolating supports + 1 lug support + 4 x 400 A busbars + 1 set of IP 2x isolating profiles
1	4 044 30	Tinned copper aluminium C-section busbars Electrolytic compatibility with copper guaranteed 250 A - height 1600 mm
1	4 044 31	400 A - height 1600 mm
		Mounting accessories for busbars at back of enclosure For mounting in XL ³ 400 enclosures The tinned copper aluminium C-section busbars must be inserted in an insulated backplate and held in place by isolating supports Busbar fixing centres 43 mm
5	4 044 36	Insulated backplate for enclosure height 1900 mm
1	4 044 37	Isolating support for aluminium C-section busbar
1	4 044 38	Isolating lug support for aluminium C-section busbar
6	4 044 39	Set of isolating profiles for IP 2x busbar protection
		Mounting accessories for aluminium busbars in cable sleeve For mounting in XL ³ 400 external cable sleeve or in XL ³ 800 internal cable sleeve
1	4 044 50	Isolating support for aluminium C-section busbar
1	4 044 51	Isolating lug support for aluminium C-section busbar
		Accessories for 250 and 400 A aluminium busbars
1	4 044 90	IP 2X 250 A tap-off terminal
80	4 044 91	M8 hammer screws

Prefabricated connection kits

Rigid copper busbars for connecting devices on VX³ 250/400 A set of aluminium busbars
Supplied with screws

For supplying a set of busbars at the back of the enclosure

1	4 044 40	Via a DPX ³ 160 with or without e.l.c.bs
1	4 044 41	Via a DPX ³ 250 with or without e.l.c.bs
1	4 044 42	Via a DPX 630 with or without e.l.c.bs
1	4 044 43	Via a DPX-IS 250
1	4 044 44	Via a DPX-IS 630

For supplying a set of busbars in a cable sleeve via a device in a cable sleeve

1	4 044 52	Via a DPX ³ 160 with or without e.l.c.bs
1	4 044 53	Via a DPX ³ 250 with or without e.l.c.bs
1	4 044 54	Via a DPX 630 with or without e.l.c.bs

For connecting a horizontal device in an enclosure on a set of busbars in a cable sleeve

1	4 044 57	Via a DPX ³ 160 with or without e.l.c.bs
1	4 044 55	Via a DPX ³ 250 with or without e.l.c.bs
1	4 044 58	For a DPX 630 with or without e.l.c.bs

For connecting a HX³ 250 row distribution block on a set of busbars in a cable sleeve

1	4 044 87	For one row distribution block Cat.No 4 044 81 equipped with side mounting power supply module Cat.No 4 044 82
---	----------	--

HX³/VX³ optimised distribution system

vertical mounting in XL³ 400 enclosures

Mounting options

Set of busbars at back of enclosure

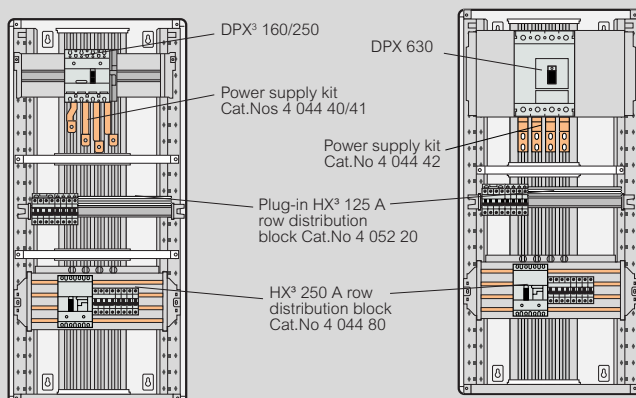

Set of busbars and main device in external cable sleeve

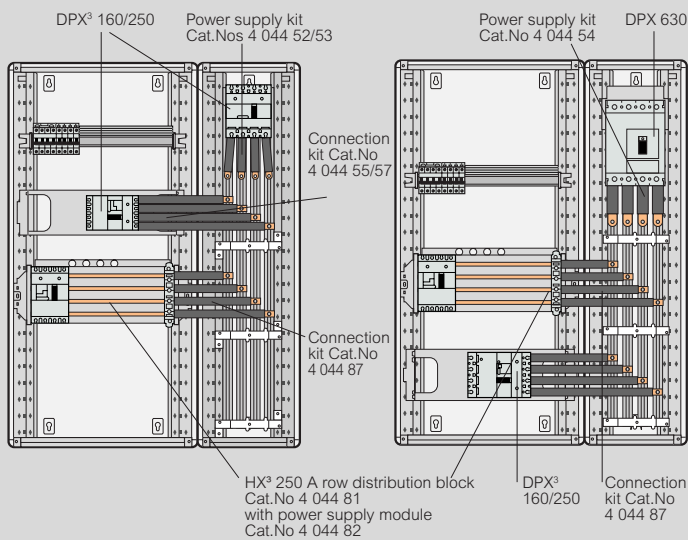

Row distribution blocks supplied by side-mounted busbars must be equipped with power supply module Cat.Nos 4 044 82/85

Set of busbars in external cable sleeve and main device in enclosure

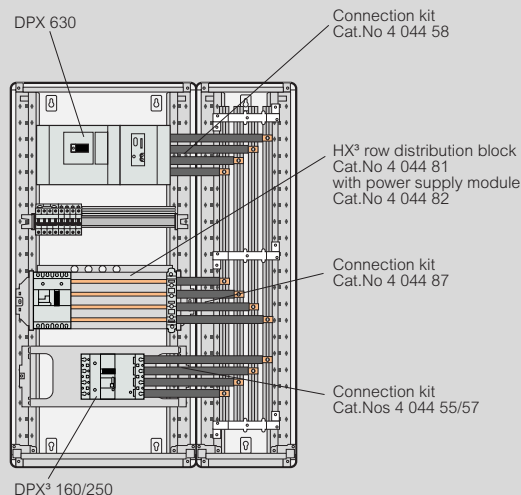

VX³ 800 A optimised distribution system

vertical mounting in XL³ 800 and XL³ 4000 enclosures

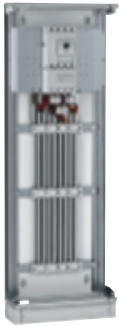

C-section bars Cat.No 4 044 33 + Supports Cat.No 4 044 60 + connection kit Cat.No 4 044 63

Technical characteristics **see opposite**

Pack	Cat.Nos	VX³ 800 A optimised distribution system of aluminium busbars
1	4 044 33	Consisting of tinned copper aluminium C-section busbars, held in place by isolating supports (to be ordered separately) Tinned copper aluminium C-section busbars Electrolytic compatibility with copper guaranteed 800 A - height 1600 mm
1	4 044 60	Mounting accessories for busbars at back of enclosure For mounting in XL ³ 800 and XL ³ 4000 enclosures
1	4 044 61	Isolating support for 800 A C-section busbars
1	4 044 62	Isolating lug support for 800 A C-section busbars
1	4 044 62	Set of isolating profiles for IP 2X busbar protection
1	4 044 70	Mounting accessories for busbars in cable sleeve For mounting in XL ³ 800 external cable sleeve
1	4 044 71	Isolating support for 800 A C-section busbars
1	4 044 71	Isolating lug support for 800 A C-section busbars
1	4 044 89	Accessories for 800 A aluminium busbars IP 2X 250 A tap-off terminal
80	4 044 92	M8 hammer screw
Prefabricated connection kits		
Pre-prepared rigid copper busbars for connecting devices on VX ³ 800 A set of aluminium busbars Supplied with screws		
1	4 044 63	For supplying a set of busbars at the back of the enclosure Via a DPX 630 with or without e.l.c.bs
1	4 044 64	Via a DPX 1600
1	4 044 65	Via a DPX-IS 630
1	4 045 30	Via a top or bottom horizontal set of aluminium busbars in XL ³ 4000 enclosure depth 725 mm
1	4 045 31	Via a top or bottom horizontal set of 1600 A copper busbars in XL ³ 4000 enclosure depth 725 mm
1	4 044 72	For supplying a set of busbars in a cable sleeve via a device in a cable sleeve Via a DPX 630 with or without e.l.c.bs
1	4 044 73	For connecting a horizontal device in an enclosure on a set of busbars in a cable sleeve Via a DPX ³ 160 with or without e.l.c.bs
1	4 044 74	Via a DPX ³ 250 with or without e.l.c.bs
1	4 044 75	For a DPX 630 with or without e.l.c.bs
1	4 044 76	For a DPX 1600
1	4 044 86	For connecting a HX³ 400 row distribution block on a set of busbars in a cable sleeve For one row distribution block Cat.No 4 044 84 equipped with side mounting power supply module Cat.No 4 044 82
1	4 044 77	For supplying the main circuit breaker upstream For a DPX 1600 mounted horizontally in an enclosure with internal cable sleeve for cable entry

HX³/VX³ optimised distribution system

vertical mounting in XL³ 800 enclosures

Mounting options

Set of busbars at back of enclosure

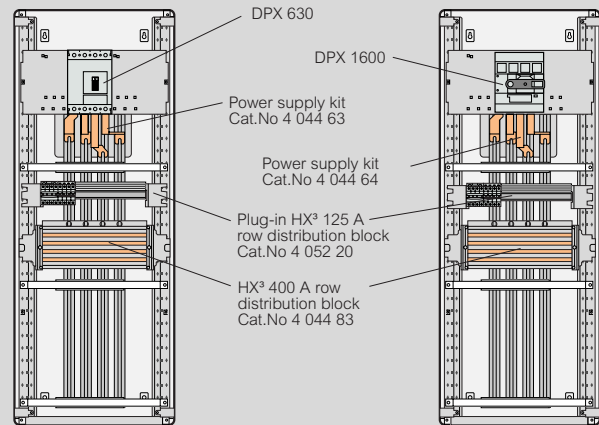

Set of busbars and main device in external cable sleeve

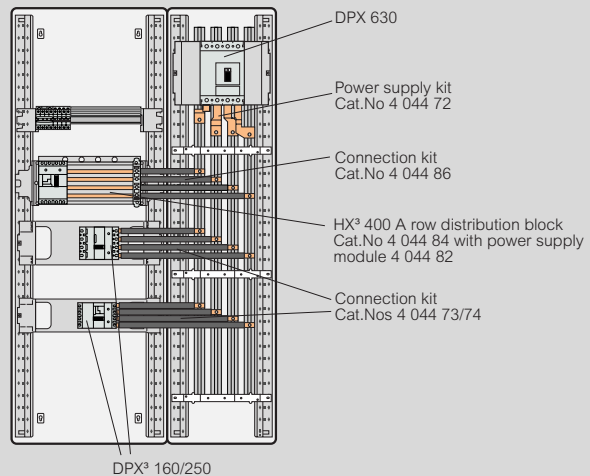

Set of busbars in external cable sleeve and main device in enclosure

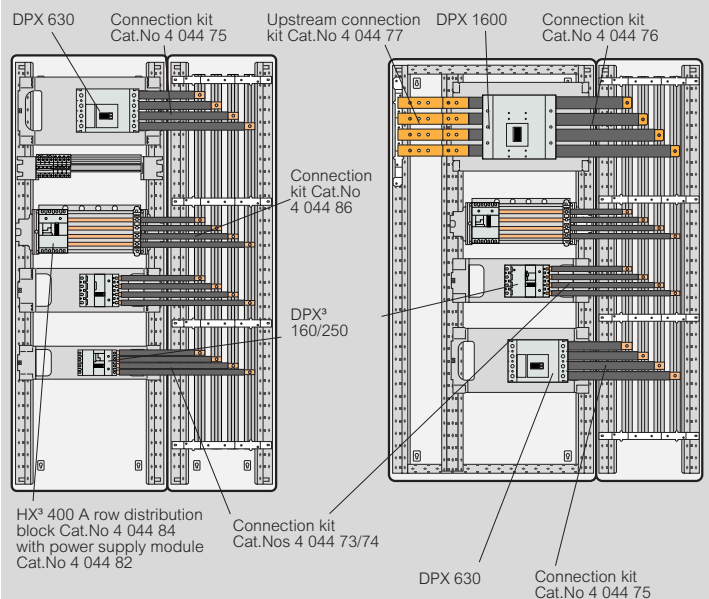

VX³/HX³ 3200 A optimised distribution system

in XL³ 4000 enclosures

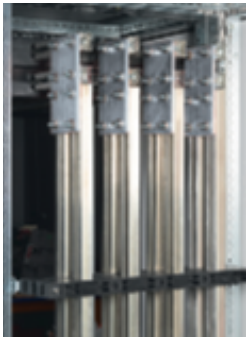

0 373 66



0 373 69

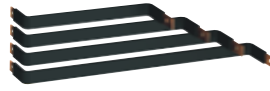

4 045 41

Dimensions p. 45
For distances between the supports p. 45

Pack	Cat.Nos	VX ³ 630 to 1600 A isolating supports
		For tinned copper aluminium C-section busbars
		Aligned busbars in enclosure or internal cable sleeve
		All configurations possible in XL ³ 4000 enclosures:
		- Vertical at the back of the enclosure
		- Side-mounted vertical behind upright
		- Side-mounted vertical in internal cable sleeve
		- Horizontal top or bottom
		- Horizontal transfer
		Insulation voltage U _i : 1000 V
		Impulse voltage U _{imp} : 8 kV
1	0 373 66	75 mm fixing centres for enclosures depth 725 mm or 475 mm in partial chassis
1	0 373 86	75 mm fixing centres for enclosures depth 975 mm
1	0 373 50	Additional support with 75 mm fixing centres for enclosure depth 725 mm
1	0 373 68	125 mm fixing centres for enclosures depth 975 mm
1	0 373 51	The support can be doubled for a current of 3200 A
		Additional support with 125 mm fixing centres for enclosure depth 975 mm
		Staggered busbars in cable sleeve
		Side-mounted vertically in cable sleeve
1	0 373 67	75 mm fixing centres for cable sleeves depth 725 mm and 475 mm
1	0 373 69	125 mm fixing centres for cable sleeves depth 975 mm
		The support can be doubled (in external cable sleeves only) for a current of 3200 A

Pack	Cat.Nos	Tinned copper aluminium C-section busbars																				
		Electrolytic compatibility with copper guaranteed																				
		Length 1780 mm																				
		<table border="1"> <thead> <tr> <th>Cross-section (mm²)</th> <th>I(A)</th> </tr> </thead> <tbody> <tr> <td></td> <td>IP ≤ 30</td> <td>IP ≥ 30</td> </tr> <tr> <td>524</td> <td>800</td> <td>630</td> </tr> <tr> <td>549</td> <td>1000</td> <td>800</td> </tr> <tr> <td>586</td> <td>1250</td> <td>1000</td> </tr> <tr> <td>686</td> <td>1450</td> <td>1250</td> </tr> <tr> <td>824</td> <td>1750</td> <td>1600</td> </tr> </tbody> </table>	Cross-section (mm ²)	I(A)		IP ≤ 30	IP ≥ 30	524	800	630	549	1000	800	586	1250	1000	686	1450	1250	824	1750	1600
Cross-section (mm ²)	I(A)																					
	IP ≤ 30	IP ≥ 30																				
524	800	630																				
549	1000	800																				
586	1250	1000																				
686	1450	1250																				
824	1750	1600																				
1	0 373 54																					
1	0 373 55																					
1	0 373 56																					
1	0 373 57																					
1	0 373 58																					

Pack	Cat.Nos	Connectors with 6 x 250 A outputs
4	0 373 99	Fixed onto aluminium C-section bars with M10 hammer screw Cat.No 0 373 59 or flat copper bars
		Output capacity:
		- 4 x 6 to 35 mm ²
		- 2 x 6 to 25 mm ²

Pack	Cat.Nos	Accessories
80	4 044 92	M8 hammer screw
4	0 373 59	M10 hammer screw
1	0 373 77	Joining kit for support Cat.Nos 0 373 66 and 0 373 68 to create sets of busbars up to 3200 A
1	4 044 89	IP 2X 250 A tap-off terminal

Pack	Cat.Nos	HX ³ row distribution block for 4 DPX ³ 160
		For direct supply of a row of 4 DPX ³ from VX ³ 630 to 1600 A aligned busbars
1	4 045 44	For busbars behind upright in enclosures depth 725 or 975 mm
1	4 045 54	For busbars in internal cable sleeve depth 475 mm
1	4 045 64	For busbars in internal cable sleeve depth 725 or 975 mm

Pack	Cat.Nos	Connection kits for VX ³ busbars
		For connecting vertical aluminium C-section busbars on horizontal busbars
		For sets of busbars with the same fixing centres
		Can be used to extend a set of busbars
1	0 373 82	1 busbar per phase
1	0 373 83	2 busbars per phase
		For sets of busbars with different fixing centres
		For connecting a vertical set of aluminium busbars with 75 mm fixing centres on a horizontal set of copper busbars up to 4000 A with 125 mm fixing centres
1	4 045 45	For vertical set of aligned busbars fixed behind functional upright in enclosure depth 725 mm
1	4 045 46	For vertical set of aligned busbars fixed behind functional upright in enclosure depth 975 mm

Pack	Cat.Nos	VX ³ prefabricated connection kits
		Pre-prepared flexible copper busbars for connecting devices on VX ³ 630 to 1600 A set of aligned aluminium busbars, 75 mm fixing centres
		Supplied with screws
		Kits for fixed circuit breakers without accessories - mounted on fixed plates
		For side-mounted set of busbars behind upright
		For mounting in enclosure depth 725 or 975 mm
1	4 045 40	For horizontal DPX ³ 160
1	4 045 41	For horizontal DPX ³ 250
1	4 045 42	For horizontal DPX 630
1	4 045 43	For row distribution block Cat.No 4 044 84
		For side-mounted set of busbars in internal cable sleeve depth 475 mm
1	4 045 50	For horizontal DPX ³ 160
1	4 045 51	For horizontal DPX ³ 250
1	4 045 52	For horizontal DPX 630
1	4 045 53	For row distribution block Cat.No 4 044 84 equipped with side mounting power supply module
		Cat.No 4 044 82
		For side-mounted set of busbars in internal cable sleeve depth 725 and 975 mm
1	4 045 60	For horizontal DPX ³ 160
1	4 045 61	For horizontal DPX ³ 250
1	4 045 62	For horizontal DPX 630
1	4 045 63	For row distribution block Cat.No 4 044 84 equipped with side mounting power supply module
		Cat.No 4 044 82

VX³/HX³ optimised distribution in XL³ 4000 enclosures

Mounting options

VX³ 800 A set of busbars at back of enclosure

XL³ 4000 depth 475 mm

Power supply via main device up to 800 A

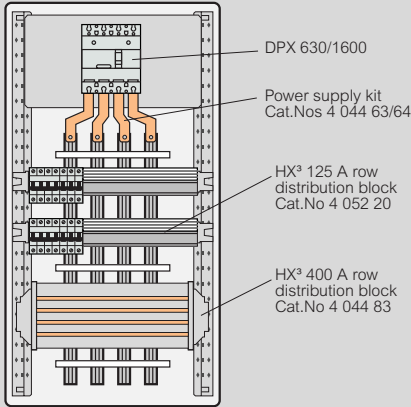

XL³ 4000 depth 725 mm

Power supply via horizontal set of copper busbars, 1 or 2 bars per pole up to 1600 A (75 mm fixing centres)

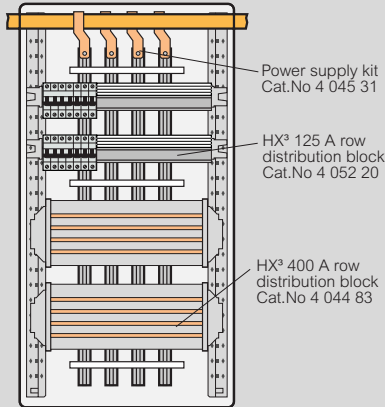
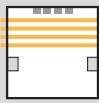

XL³ 4000 depth 725 mm

Power supply via horizontal set of aluminium busbars, 1 bar up to 1600 A (75 mm fixing centres)

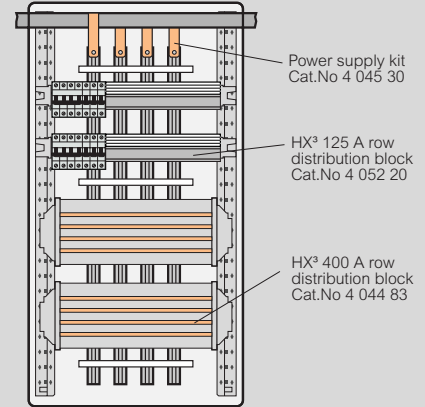
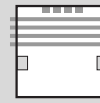

VX³ 630 to 1600 A set of aligned busbars, 75 mm fixing centres, mounted side by side in enclosure behind functional upright



XL³ 4000 depth 725 or 975 mm
Power supply via horizontal set of copper busbars, 1 or 2 bars per pole up to 1600 A (75 mm fixing centres)

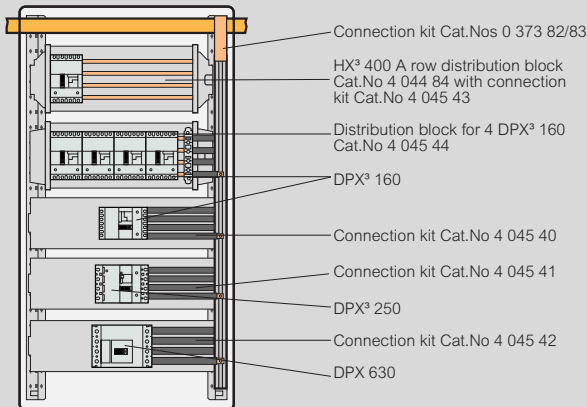

XL³ 4000 depth 725 or 975 mm
Power supply via horizontal set of copper busbars, 1 to 3 bars per pole up to 4000 A (125 mm fixing centres)

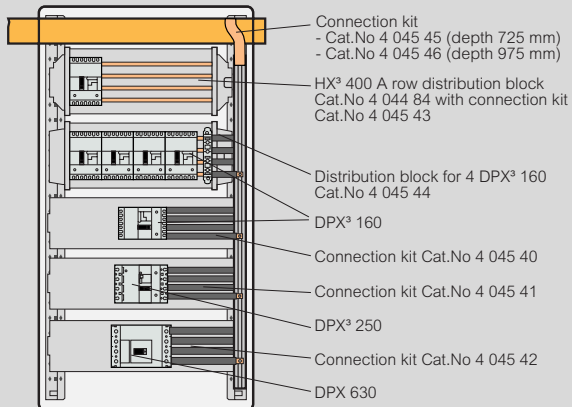

VX³ 630 to 1600 A set of aligned busbars, 75 mm fixing centres, mounted side by side in internal cable sleeve

XL³ 4000 depth 475 mm with partial chassis

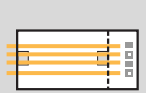

Power supply via horizontal set of copper busbars, 1 or 2 bars per pole up to 1600 A (75 mm fixing centres)

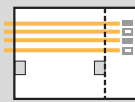
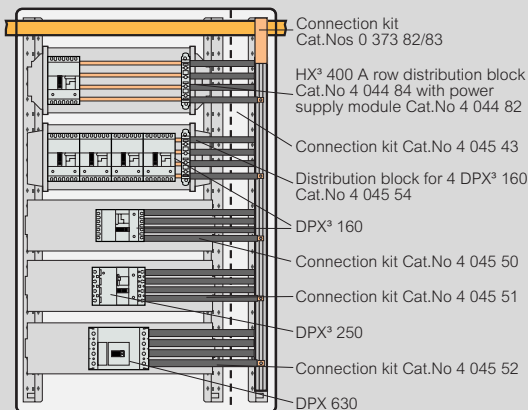

Power supply via horizontal set of copper busbars, 1 or 2 bars per pole up to 1600 A (75 mm fixing centres)

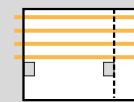
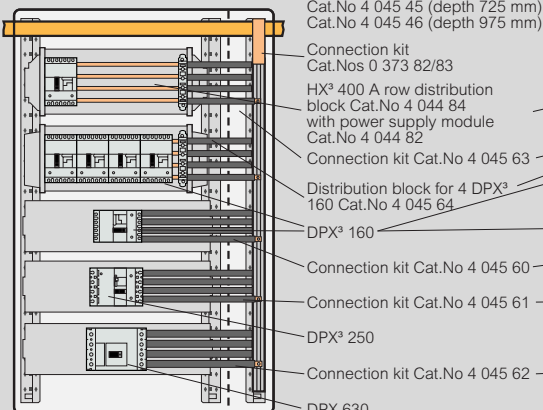

Power supply via horizontal set of copper busbars, 1 to 3 bars per pole up to 4000 A (125 mm fixing centres)
Partial chassis, depth 725

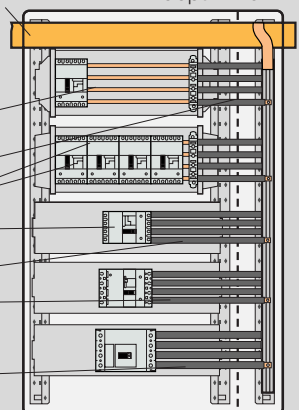

Kits de raccords VX³ optimisées jusqu'à 4000 A - en armoires XL³ 4000

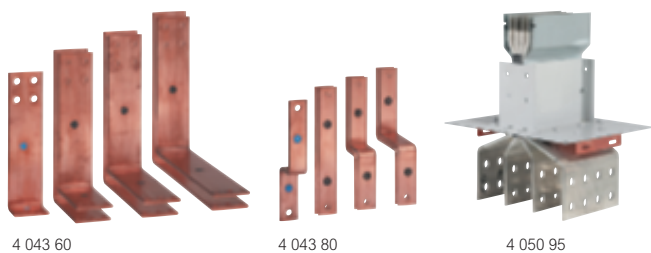

Pack	Cat.Nos	Connection kits for transfer
		Angled, drilled copper bars for downstream connection of devices on horizontal aluminium transfer busbars, fixing centres 75 mm The busbars can be installed at the top or the bottom
		For size 2 DMX³ - 2500 or 3200 A For mounting in XL ³ 4000 enclosures depth 725 mm and 975 mm
1	4 043 60	For fixed version
1	4 043 61	For inverter fixed version
1	4 043 62	For draw-out version
1	4 043 63	For DMX ³ inverter, draw-out version
		For size 1 DMX³ - 1000 to 2000 A For mounting in XL ³ 4000 enclosures depth 725 mm and 975 mm
1	4 043 64	For fixed version - 2 bars per pole 1600 to 2000 A
1	4 043 65	For inverter fixed version - 2 bars per pole 1600 to 2000 A
1	4 043 66	For draw-out version - 2 bars per pole 1600 to 2000 A
1	4 043 67	For DMX ³ inverter draw-out version 2 bars per pole 1600 to 2000 A
1	4 043 68	For fixed version - 1 bar per pole up to 1600 A
1	4 043 69	For inverter fixed version - 1 bar per pole up to 1600 A
1	4 043 70	For draw-out version - 1 bar per pole up to 1600 A
1	4 043 71	For DMX ³ inverter draw-out version 1 bar per pole up to 1600 A
		For vertical DPX 1600
1	4 043 80	For fixed version with front terminals in XL ³ 4000 depth 475 mm
1	4 043 81	For fixed version with front terminals in XL ³ 4000 depth 725 mm
1	4 043 82	For draw-out version with front terminals in XL ³ 4000 depth 725 mm
1	4 043 83	For fixed version with rear terminals in XL ³ 4000 depth 725 mm
1	4 043 84	For draw-out version with rear terminals in XL ³ 4000 depth 725 mm
		DMX³ connection kits for SCP connection interfaces
		Angled, drilled bars for upstream connection of DMX ³ on prefabricated busbar system entries For mounting in XL ³ 4000 enclosures depth 725 mm and 975 mm
1	4 043 00	For 1600 A SCP entry, fixed version
1	4 043 01	For 2000 A SCP entry, fixed version
1	4 043 02	For 2500 A SCP entry, fixed version
1	4 043 03	For 1600 A SCP entry, draw-out version
1	4 043 04	For 2000 A SCP entry, draw-out version
1	4 043 05	For 2500 A SCP entry, draw-out version
		SCP connection interfaces for XL³ enclosures
		Elements used for connecting SCP Zucchini busbars to XL ³ 4000 enclosures To be used with the set of 2 roof reinforcement brackets Cat.No 0 205 29
1	4 050 90	630 A
1	4 050 92	1000 A
1	4 050 93	1250 A
1	4 050 94	1600 A
1	4 050 95	2000 A
1	4 050 96	2500 A
1	4 050 97	3200 A
1	4 050 98	4000 A

VX³ kits for optimised connection in XL³ 4000 enclosures

Downstream connection of DMX³ on transfer busbar

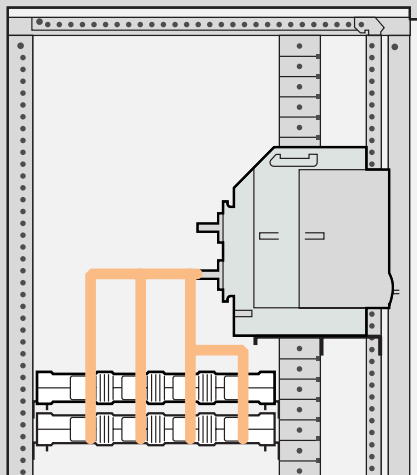

Connection of DMX³ supply inverters on transfer busbar

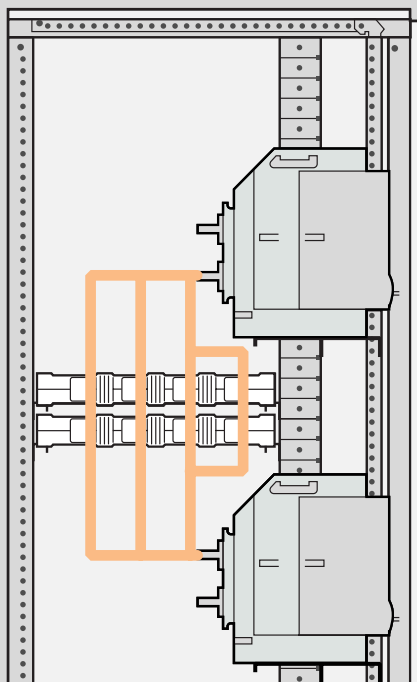

Vertical DPX 1600 connection on transfer busbar

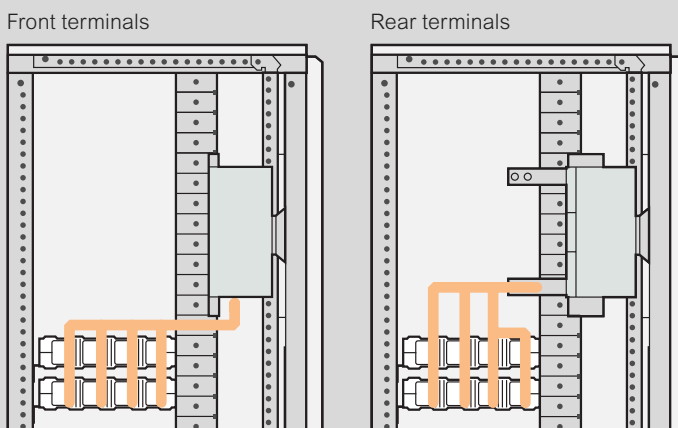

VX³ optimised vertical distribution system

VX³ 400 A aluminium busbars

Insulation voltage in accordance with EN 60947-1/IEC 60664-1: 1000 V_~
 Impulse voltage (U_{imp}): 8 kV

Determining the maximum distances between the supports (mm)

Bars	4 044 37/38 Insulated backplate		4 044 50/51 Staggered in cable sleeve	
	4 044 30	4 044 31	4 044 30	4 044 31
10	1600	1800	1600	1600
21	1600	1800	800	800
30	800	1000	400	500
40	800	800	350	400
52	400	600	250	300

Dimensions (mm)

Cat. Nos 4 044 50/51

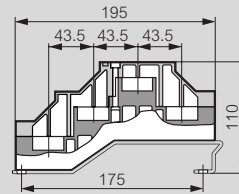

VX³ 800 A aluminium busbars

Insulation voltage in accordance with EN 60947-1/IEC 60664-1: 1000 V_~
 Impulse voltage (U_{imp}): 8 kV

Determining the maximum distances between the supports (mm)

Bars	4 044 60/61 Back of enclosure		4 044 70/71 Staggered in cable sleeve	
	4 044 33		4 044 33	
30	1600	1600	1600	1600
40	1000	1000	1000	1000
52	800	800	800	800
63	700	700	700	700
73	600	600	600	600
80	500	600	600	600
94	400	500	500	500
105	400	500	500	500

Dimensions (mm)

Cat. Nos 4 044 60/61

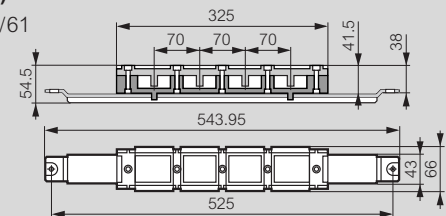

Cat. Nos 4 044 70/71

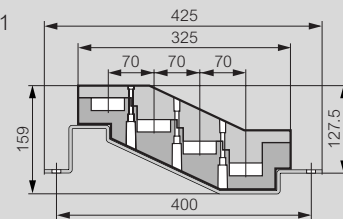

VX³ 630 to 1600 A aluminium busbars

Insulation voltage in accordance with EN 60947-1/IEC 60664-1: 1000 V_~
 Impulse voltage (U_{imp}): 8 kV

Determining the maximum distances between the supports (mm)

Bars	0 373 50/66/67 1 C-section aluminium bar per pole					0 373 51/68/69 1 C-section aluminium bar per pole				
	0 373 54	0 373 55	0 373 56	0 373 57	0 373 58	0 373 54	0 373 55	0 373 56	0 373 57	0 373 58
30	1600	1600	1600	1600	1600	1600	1600	1600	1600	1600
40	1000	1000	1000	1000	1000	1000	1000	1000	1000	1000
52	800	800	800	800	800	800	800	800	800	800
63	700	700	700	700	700	600	600	600	600	600
73	600	600	600	600	600	500	500	500	500	500
80	600	600	600	600	600	500	500	500	500	500
94	500	500	500	500	500	400	400	400	400	400
105	500	500	500	500	500	400	400	400	400	400
132	-	-	500	500	500	-	-	400	400	400
154	-	-	400	400	400	-	-	300	300	300

Dimensions (mm)

Cat. Nos 0 373 50/51/66/68

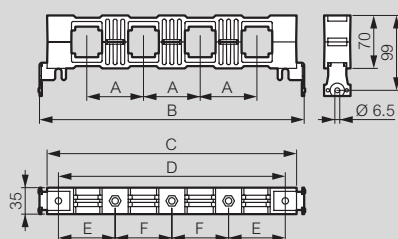

Cat. Nos 0 373 67/69

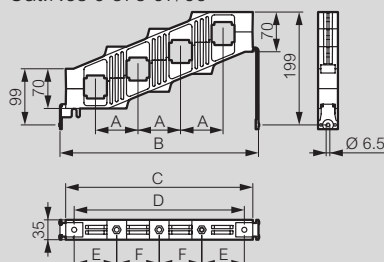

Cat. Nos	A	B	C	D	E	F
0 373 66	75	350	330	300	75	75
0 373 68	125	600	580	550	150	125
0 373 67	75	350	330	300	75	75
0 373 69	125	600	580	550	150	125
0 373 50	75	-	330	300	75	75
0 373 51	125	-	580	550	150	125



IS 223, IS 233 IS 333

The service index (IS) guarantees the level of service of the panel for operation, maintenance and upgrade operations. With the VX³ IS IPxxB increased safety aluminium busbar, Legrand is providing innovative solutions for levels 223, 233 and 333

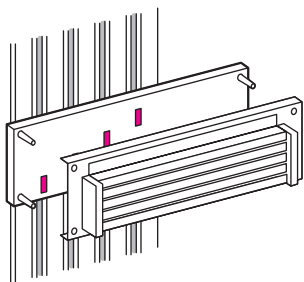

■ **IS 223:**
- Optimum upgrading
The automatic connection bases enable a device or a row distribution block to be added without having to switch off the panel

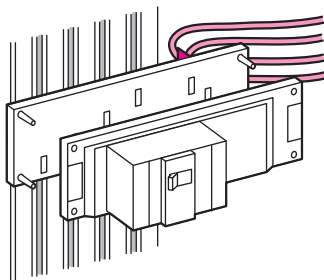

■ **IS 233:**
- Optimum upgrading
- Optimum maintenance
A device is replaced without doing anything to the connections

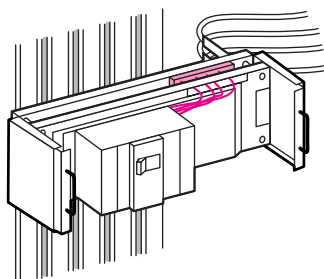

■ **IS 333:**
- Optimum upgrading
- Optimum maintenance
- Optimum operation
A "test" position enables a device to be disconnected while keeping the auxiliaries connected

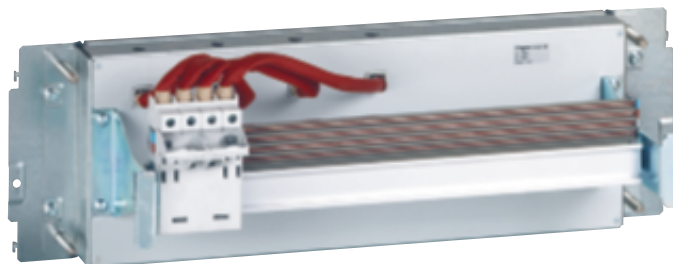

4 046 68



4 052 43



4 052 44



4 052 45



4 052 46

Technical characteristics p. 47

Pack	Cat.Nos	HX ³ 125 A IS 223 row distribution block
1	4 046 68	Plug-in distribution block For mounting on functional uprights in XL ³ 4000 Automatic connection and disconnection on the VX ³ IS column chassis in accordance with IS 223 Base with power supply via clamps, equipped with HX ³ 125 A row distribution block and pre-wired power supply module (can not be removed) Width: 24 modules Capacity: 20 modules
1	4 052 43	Connection modules Used for automatic connection and disconnection of modular devices on the 125 A row distribution block For 1 module per pole devices Pack of 10 connection modules L1
1	4 052 44	Pack of 10 connection modules L2
1	4 052 45	Pack of 10 connection modules L3
1	4 052 46	Pack of 10 connection modules N

HX³ - IS increased safety distribution system up to 400 A - horizontal mounting in XL³ 4000 enclosures

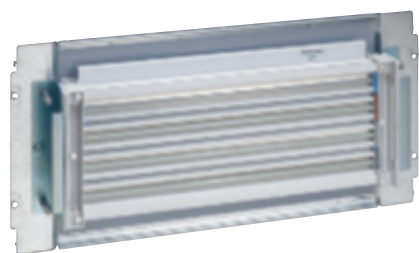

4 046 60

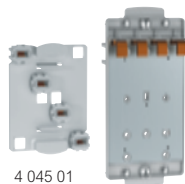

4 045 01

Technical characteristics **see opposite**

Pack	Cat.Nos	HX³ 400 A IS 223 row distribution block
1	4 046 60	For mounting on functional uprights in XL3 4000 Automatic connection and disconnection on the VX ³ IS column chassis in accordance with IS 223 Takes the 4-pole bases for DPX ³ and the bases for modular devices 24-module distribution block with power supply via clamps
		HX³ support bases for DPX³ MCCBs
		For automatic connection of DPX ³ MCCBs with or without e.l.c.bs on HX ³ 400 A IS 223 row distribution blocks Supplied with terminal shields
		For DPX³ 160
1	4 045 00	3P
1	4 045 01	4P with or without e.l.c.bs
		For DPX³ 250
1	4 045 02	3P
1	4 045 03	4P with or without e.l.c.bs
		HX³ support bases for DX³ modular devices
		For automatic connection of DX ³ devices on HX ³ 400 A IS 223 row distribution blocks The bases are supplied via the distribution block
		Plug-in base for 1 module per pole DX³
1	4 045 08	For 4-pole DX ³
1	4 045 09	For 3-pole DX ³
1	4 045 10	For single pole DX ³ - Phase L1
1	4 045 11	For single pole DX ³ - Phase L2
1	4 045 12	For single pole DX ³ - Phase L3
1	4 045 13	For single pole DX ³ - Neutral N
		Wired bases for 1.5 module per pole DX³
1	4 045 15	For 4-pole DX ³
1	4 045 16	For 3-pole DX ³
1	4 045 17	For single pole DX ³ - Neutral N
1	4 045 18	For single pole DX ³ - Phase L1
1	4 045 19	For single pole DX ³ - Phase L2
1	4 045 20	For single pole DX ³ - Phase L3
		Wired bases for 1 module per pole DX³ - In ≤ 63 A
1	4 045 21	For 4-pole DX ³
1	4 045 22	For 3-pole DX ³
1	4 045 23	For single pole DX ³ - Neutral N
1	4 045 24	For single pole DX ³ - Phase L1
1	4 045 25	For single pole DX ³ - Phase L2
1	4 045 26	For single pole DX ³ - Phase L3
		Universal base
1	4 045 27	Empty base, 1 module without power supply

HX³ - IS increased safety distribution system horizontal mounting

HX³ 125 A IS row distribution block

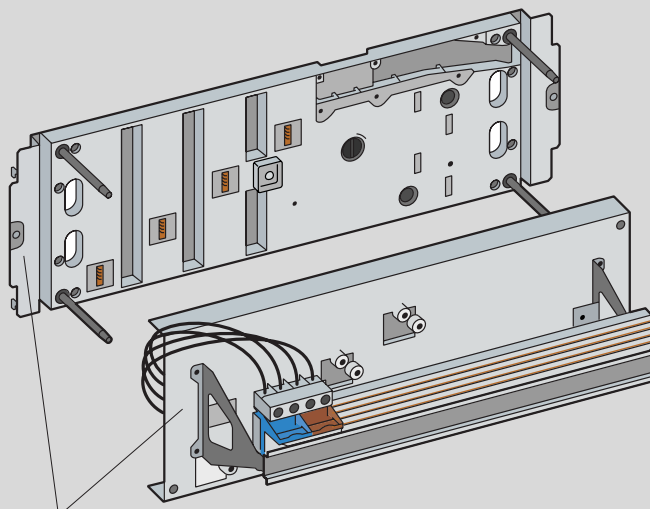

HX³ 125 A IS 223 row distribution block
Cat.No 4 046 68

HX³ 400 A IS row distribution block

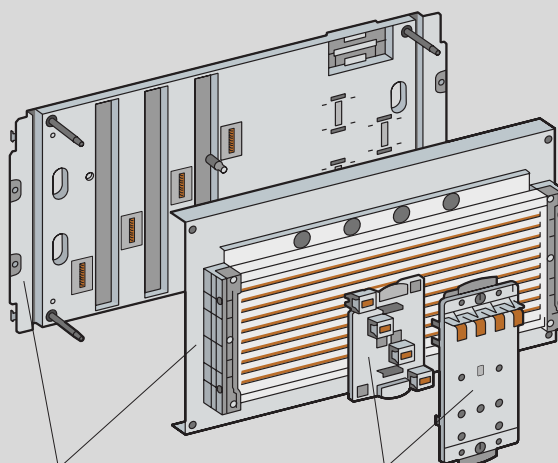

HX³ 400 A IS 223 row distribution block
Cat.No 4 046 60

HX³ support base for DPX³
Cat.Nos 4 045 01/03

VX³ 2000 - IS increased safety distribution system up to 2000 A

vertical mounting in XL³ 4000 enclosures

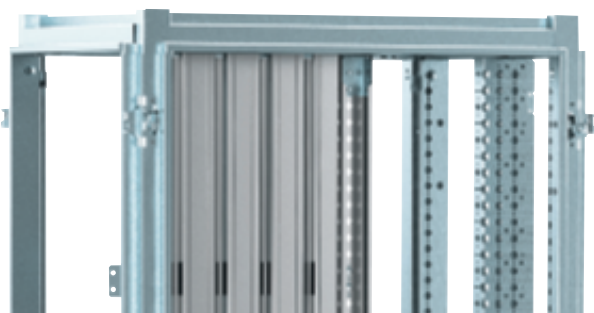

4 046 00

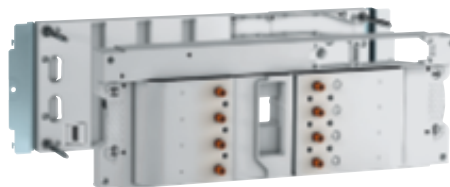

4 046 23



4 046 59

Pack	Cat.Nos	VX ³ IS xx3 column chassis
		Tinned copper aluminium busbar Special profile for automatic connection via clamps Takes VX ³ IS bases for devices and HX ³ IS row distribution blocks For distribution conforming to IS 223, 233 and 333 according to the bases and distribution blocks installed Supplied with partitions for form 4b For mounting in XL ³ 4000 enclosures
		VX³ IS chassis Chassis consisting of an upright and isolating supports for aluminium bars For XL ³ 4000 enclosure height 2200 mm
	Depth of enclosure (mm)	
	725 975	
1	4 046 00 4 046 02	
1	0 208 55	Faceplate support frames Fixed for 725 mm width enclosure or 975 mm width enclosure without internal wiring sleeve
1	0 208 56	Fixed for 975 mm width enclosure with internal wiring sleeve
		VX³ IS xx3 tinned copper aluminium bars Front profile for automatic connection Rear C-section profile for power supply Equipped with IP 2X isolating profiles Height 1800 mm
1	4 046 04	1250 A
1	4 046 06	2000 A

Pack	Cat.Nos	VX ³ IS bases for devices
		For fixing on the functional uprights Power supply via clamps Automatic connection and disconnection on the VX ³ IS column chassis
		VX³ IS 223 bases Automatic upstream connection Downstream connection via front terminals
1	3P 4P	
1	4 046 10 4 046 11	For DPX ³ 160 with or without e.l.c.bs
1	4 046 12 4 046 13	For DPX ³ 250 with or without e.l.c.bs
1	4 046 16 4 046 17	For DPX 630 with or without e.l.c.bs
		VX³ IS 233 bases Automatic upstream connection Automatic downstream connection
1	4 046 20 4 046 21	For DPX ³ 160 without e.l.c.bs
1	4 046 22 4 046 23	For DPX ³ 250 without e.l.c.bs
1	4 046 26 4 046 27	For DPX 630 without e.l.c.bs
1	4 046 31	For DPX ³ 160 with e.l.c.bs
1	4 046 33	For DPX ³ 250 with e.l.c.bs
1	4 046 36 4 046 37	For DPX 630 with e.l.c.bs
		VX³ IS 333 bases Automatic upstream connection Automatic downstream connection Base for automatic connection module for auxiliaries
1	4 046 40 4 046 41	For DPX ³ - 160 without e.l.c.bs
1	4 046 42 4 046 43	For DPX ³ - 250 without e.l.c.bs
1	4 046 46 4 046 47	For DPX 630 without e.l.c.bs
1	4 046 51	For DPX ³ - 160 with e.l.c.bs
1	4 046 53	For DPX ³ - 250 with e.l.c.bs
1	4 046 56 4 046 57	For DPX 630 with e.l.c.bs

Pack	Cat.Nos	Equipment for IS increased safety distribution system
		Special IS 223/233 faceplates Faceplates with hinges and lock
1	4 046 70	For 3P/4P DPX ³ 160/250 with no accessory Height 200 mm
1	4 046 71	For 3P/4P DPX 630 with no accessory Height 300 mm
10	4 046 72	For 3P/4P DPX ³ 160/250 with rotary or motor-driven handle - Height 200 mm
1	4 046 73	For 3P/4P DPX 630 with rotary or motor-driven handle - Height 300 mm
1	4 046 74	Faceplate for HX ³ 400 A IS row distribution block Height 300 mm
10	4 046 75	Faceplate for HX ³ 125 A IS row distribution block Height 200 mm
		Special IS 333 faceplates
x	4 046 76	Faceplate for HX ³ 400 A IS row distribution block Height 300 mm
x	4 046 77	Faceplate for HX ³ 125 A IS row distribution block Height 200 mm
1	4 046 80	For 3P/4P DPX ³ 160/250 with no accessory Height 200 mm
1	4 046 81	For 3P/4P DPX 630 with no accessory Height 300 mm
5	4 046 82	For 3P/4P DPX ³ 160/250 with rotary or motor-driven handle - Height 200 mm
1	4 046 83	For 3P/4P DPX 630 with rotary or motor-driven handle - Height 300 mm
		Mounting lugs for standard screw-mounting faceplates (4 lugs) for IS 333 only
20	4 046 79	
		Universal bases (height 300 mm)
1	4 046 65	IS 223
1	4 046 66	IS 233
1	4 046 67	IS 333
		Connection kits on horizontal busbars Linking bars prepared for supplying the VX ³ IS column chassis via the main top or bottom horizontal busbar Supplied with partitioning housing for the horizontal busbar
1	4 046 90	For 4000 A copper busbars, In 1250 A (fixing centres 125 mm)
1	4 046 91	For 4000 A copper busbars, In 2000 A (fixing centres 125 mm)
1	4 046 92	For 1600 A aluminium busbars, In 1250 A (fixing centres 75 mm)
1	4 046 93	For 3200 A aluminium busbars, In 2000 A (fixing centres 75 mm)
		Connection module for auxiliaries for IS 223 and IS 233 bases (supplied with IS 333 bases)
1	4 046 59	
		Partitioning for form
1	4 046 85	Partitioning kit for horizontal busbars in internal wiring sleeve
1	4 046 86	Partitioning kit for horizontal busbars in external wiring sleeve
1	4 046 87	IS 233/333 rear partitioning kit, height 200 mm
1	4 046 88	IS 233/333 rear partitioning kit, height 300 mm
1	4 046 89	Partition, height 300 mm, for reserve

VX³ - IS increased safety distribution system, vertical mounting

Mounting

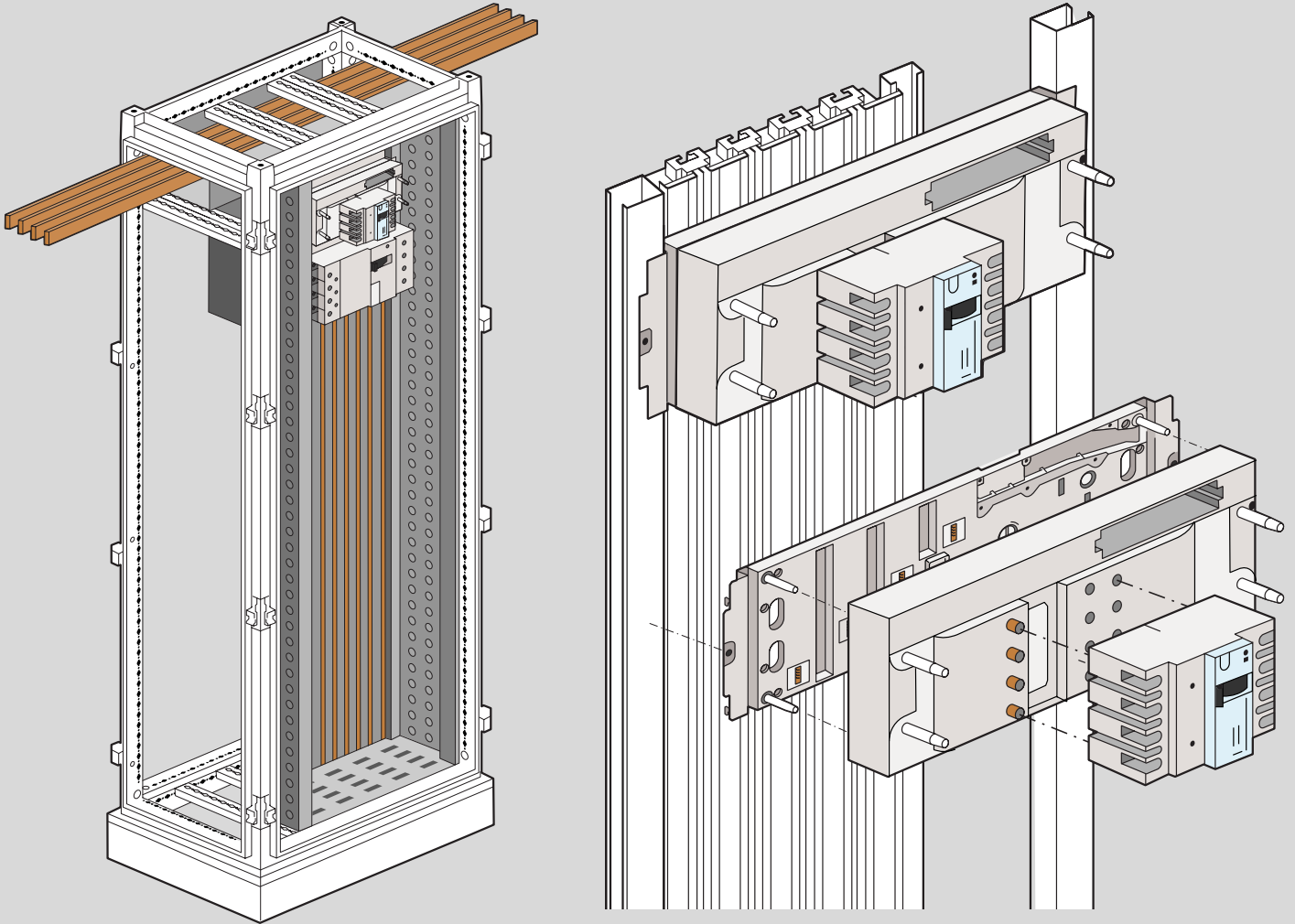

Dimensions (mm)

Bases for DPX³ 160

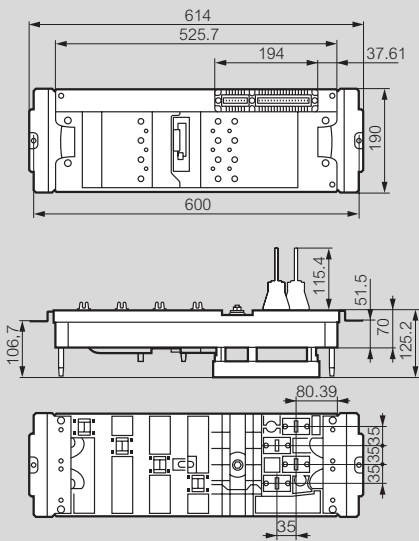

Bases for DPX³ 250

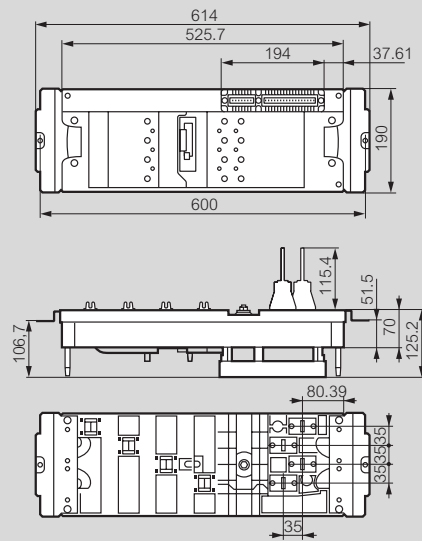

Bases for DPX³ 630

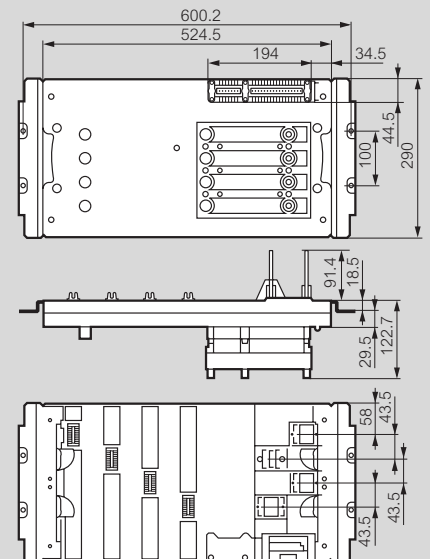



FOLLOW US ON

@ website: www.legrand.eg

f legrand

legrandegypt



EMB Electrical Industries S.A.E.

Headquarter office

Pyramids Heights Office Park
KM 22 Cairo - Alex. desert road
Building 1B, 12556
Tel.: +202 3536 0000
Fax: +202 3536 0001
www.legrand.eg