

Practibox S

A WELL-DESIGNED
RANGE



-> CATALOGUE PAGES INSIDE

READY TO USE CABINETS
FROM 4 TO 72 MODULES

GLOBAL SPECIALIST
IN ELECTRICAL AND DIGITAL BUILDING INFRASTRUCTURES

 **legrand**[®]

PRACTIBOX S

A WELL-DESIGNED RANGE OF CABINETS

WELL-DESIGNED, BECAUSE IT FITS IN INSTALLATION PRACTICES THROUGHOUT THE WORLD, ALLOWING EVERYONE TO APPRECIATE THE EASE OF INSTALLATION AND WIRING OF ITS CABINETS, WHILE OFFERING MAXIMUM USER CONVENIENCE WITH A WIDE CHOICE OF SIZES. ALSO WELL-DESIGNED IN THAT ITS CABINETS ARE NOT AFRAID TO BE ON SHOW DUE TO THEIR ATTRACTIVE APPEARANCE DESIGNED FOR THE RESIDENTIAL SECTOR, BOTH HOUSES AND FLATS, AND FOR SMALL OFFICE BUILDINGS. THIS INGENUOUS RANGE HAS NUMEROUS FEATURES WHICH WILL SEDUCE YOU, INCLUDING LEGRAND'S FAMED QUALITY.



A TIMELESS STREAMLINED DESIGN WHICH BLENDS IN HARMONIOUSLY AT HOME AND IN THE WORKPLACE.

CONTENTS

PRACTIBOX S

A range which adapts to you..... 2

FLUSH-MOUNTING CABINETS

The solution which can be incorporated in any wall..... 4

SURFACE-MOUNTING CABINETS

The ideal solution for refurbishment..... 6

CATALOGUE PAGES..... 8



WITH NO PROTRUDING EDGES, A GENTLY ROUNDED SHAPE SOFTENS THE APPEARANCE OF THIS RANGE

PRACTIBOX S

A RESISTANT & COMPREHENSIVE RANGE

Covers the whole
range of needs on
your work sites

Thanks to an extensive offer scope, Practibox S cabinets adapt to any configuration regardless of the type of installation, flush-mounted in concrete, brick or dry partitions, or even surface-mounted. Resistant to impacts and fire up to 850°, they all comply with the applicable standards.

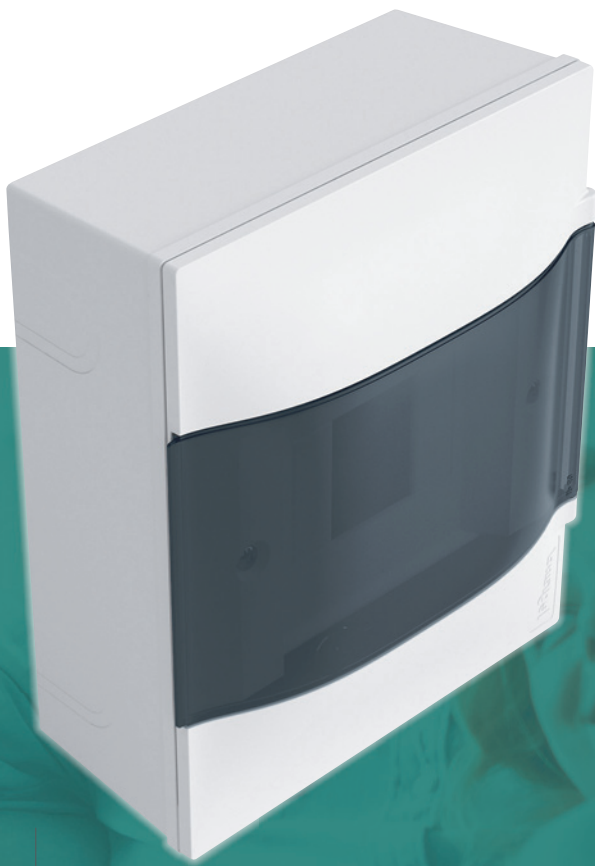

SURFACE-MOUNTING VERSION

Supplied with:

- smoked frosted transparent door or white door
- without terminal blocks or
- with earth terminal block or
- with neutral and earth terminal blocks

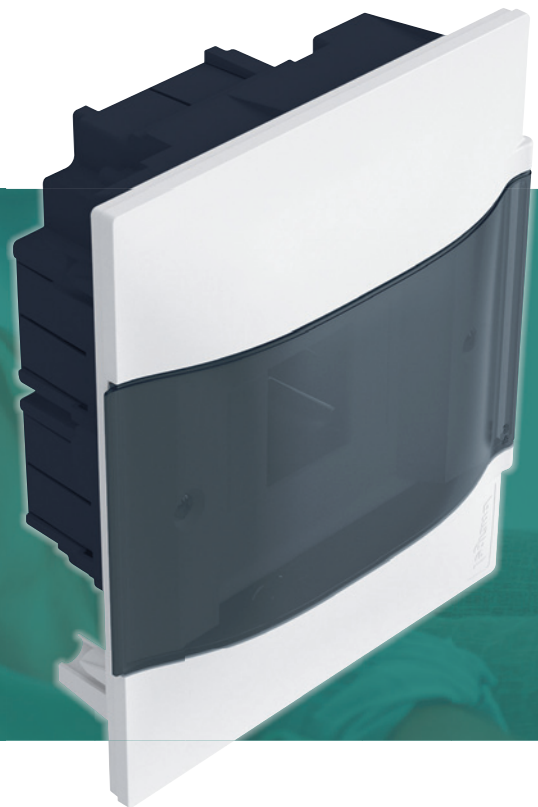

FLUSH-MOUNTING VERSION

• for concrete and bricks or for dry partitions

Supplied with:

- smoked frosted transparent door or white door
- without terminal blocks or
- with earth terminal block or
- with neutral and earth terminal blocks

NEW PACKAGING,
CONTAINING CLEARLY-LEGIBLE
INFORMATION TO MAKE PRODUCT
SELECTION EASIER



CUT-OUT ON THE BACK OF THE
PACKAGING. PROTECTS THE
FLUSH-MOUNTING BOX DURING
INSTALLATION

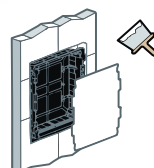

AVAILABLE IN:

- 4, 6, 8, 12, 18, 22 MODULES
- 1 TO 4 ROWS

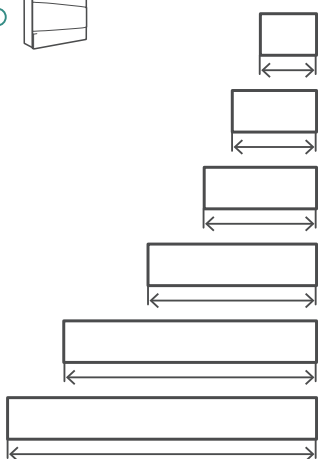

4 M	● ○			
6 M	●			
8 M	● ○			
12 M	● ○	● ○	● ○	● ○
18 M	● ○	● ○	● ○	● ○
22 M	● ○			

THE GUARANTEE OF A HIGH-QUALITY RANGE WHICH COMPLIES WITH THE STANDARDS

IEC 60670-24

FOR CREATING INSTALLATIONS COMPLIANT
WITH STANDARD IEC 61439-3



CLASS II



IP 40



IK 07

FLUSH-MOUNTING CABINETS

THE SOLUTION WHICH CAN BE INCORPORATED IN ANY WALL

Ease and speed of installation and wiring

In concrete, brick or in dry partitions, Practibox S flush-mounting cabinets have been designed to simplify installation and wiring, thus saving a significant amount of time on work sites, while ensuring a perfect finish, Legrand's commitment to quality.

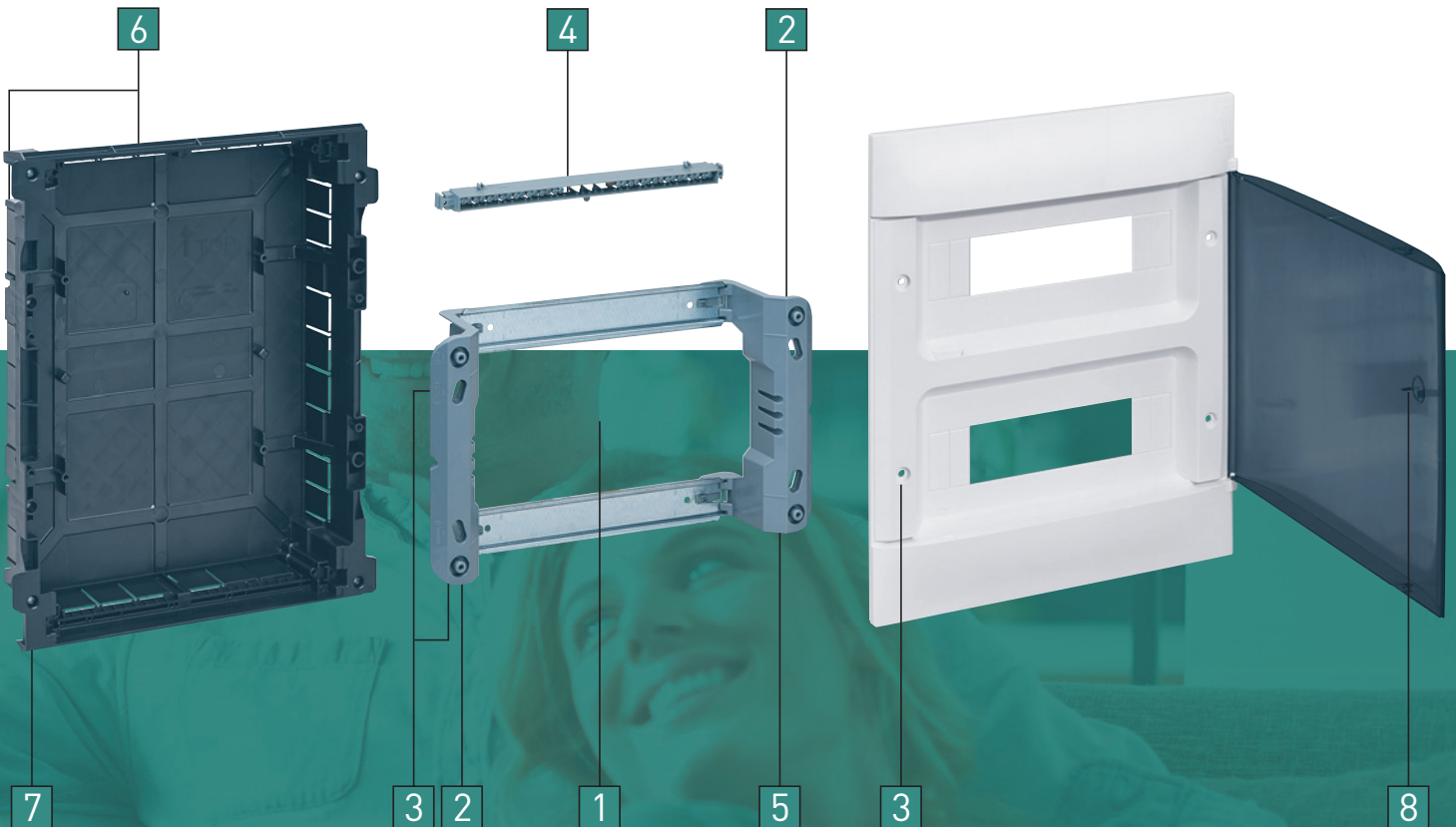

FIRE RESISTANCE

MASONRY VERSION

up to 650°



DRY PARTITIONS VERSION

up to 850°

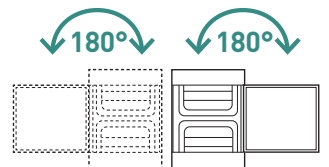

CABINET AND REVERSIBLE DOORS. DOOR OPENS TO 180°

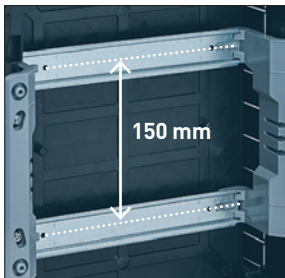

1 FIXING DISTANCE BETWEEN RAILS
Optimised wiring space for easier access to terminals.

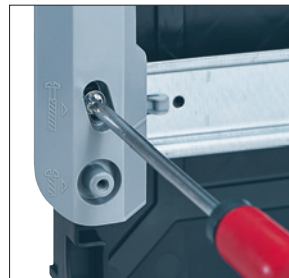

2 REMOVABLE FRAME
Allows wiring in the workshop. Vertical level adjustment possible thanks to the oblong holes.



3 IDENTIFICATION OF SCREWS
Marking which helps identify the screws to be used:
• long screws: frame
• short screws: faceplate
Compatible with flat-blade or Phillips screwdrivers.

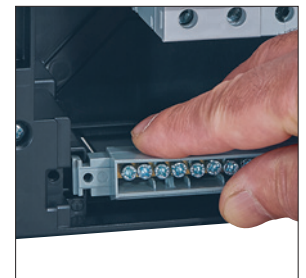

4 HORIZONTAL TERMINAL BLOCKS
Cabinets equipped with terminal blocks (earth or neutral and earth) or which can easily accommodate terminal blocks. Easy toolless installation.



5 SLOTS FOR SIDE TERMINAL BLOCKS
Option of adding IP 2X terminal blocks.
Easy toolless installation.

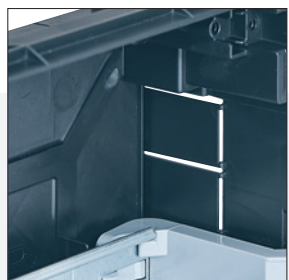

6 CABLE ENTRIES
Cut-out entries all around the box for feeding through cables or trunking.

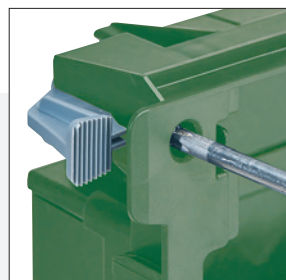

7 FIXING LUGS
These are supplied directly with the cabinets for dry partitions.

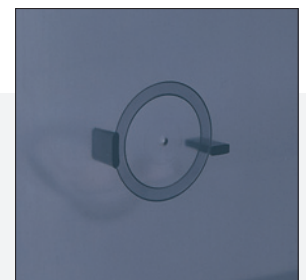

8 KEY-OPERATED LOCK
Cut-out slot on the door for key-operated lock.

NUMEROUS ADVANTAGES

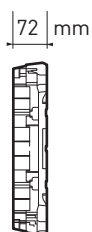

SLIM DIMENSIONS OR EASY INTEGRATION, EVEN IN DRY PARTITIONS

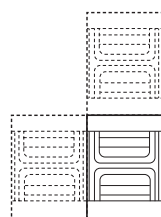

OPTION OF JOINING CABINETS WITH A DEDICATED KIT. TO BE ORDERED SEPARATELY

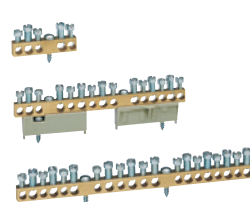

POSSIBILITY TO ACCOMMODATE BARE BRASS TERMINAL BLOCKS (EARTH AND/OR NEUTRAL)



POSSIBILITY TO ADD BARE BRASS TERMINALS TO TERMINAL BLOCK SUPPLIED WITH THE CABINETS

SURFACE-MOUNTING CABINETS

THE IDEAL SOLUTION FOR REFURBISHMENT

Easier,
faster wiring

Practibox S surface-mounting cabinets have been designed in the same way as the flush-mounting cabinets, with the same aim in mind: saving time while making it easier to do the wiring in greater comfort. However, some variants are associated with the surface-mounting cabinet configuration.

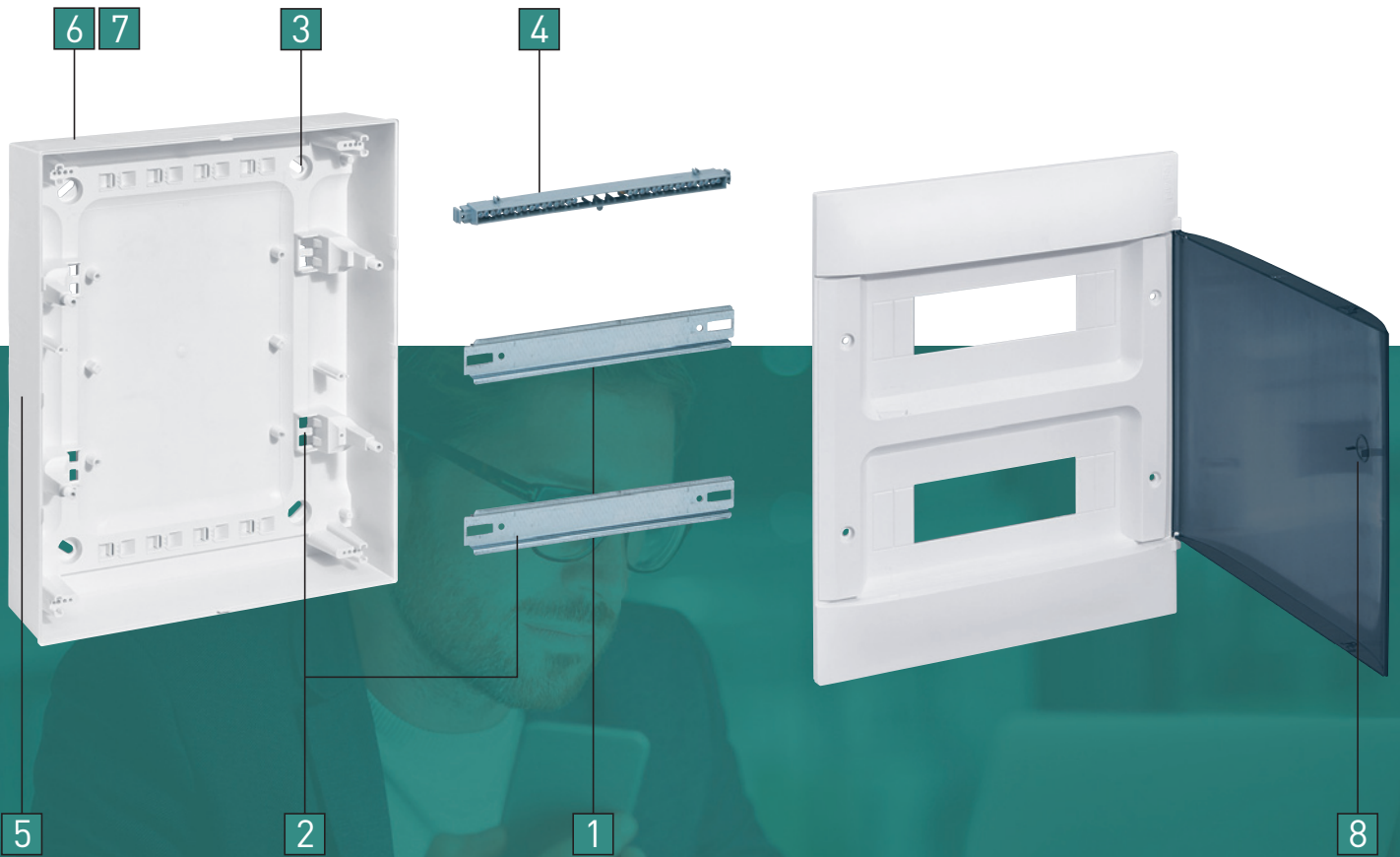

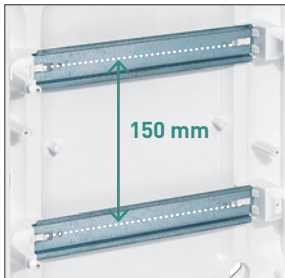

1 FIXING DISTANCE BETWEEN RAILS
Optimised wiring space for easier access to terminals.

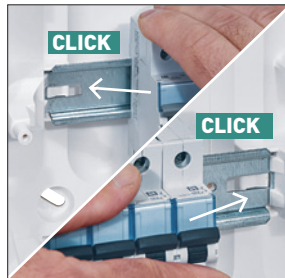

2 EASIER RAIL FITTING
Allows prewiring in the workshop. Simplified rail fitting, without screws or tools.

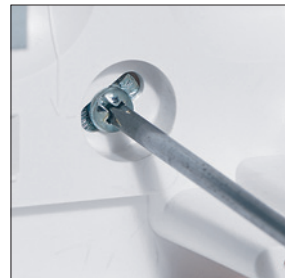

3 VERTICAL LEVEL ADJUSTMENT AND INSTALLATION TEMPLATE
Vertical level adjustment possible thanks to the oblong holes. Fixing centre dimensions marked on the back of the cabinet.

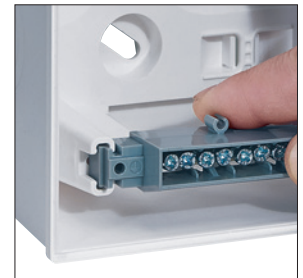

4 HORIZONTAL TERMINAL BLOCKS
Cabinets equipped with terminal blocks (earth or neutral and earth) or which can easily accommodate terminal blocks. Easy toolless installation.



5 CABLE ENTRIES
Cut-out entries on the sides for feeding through trunking.

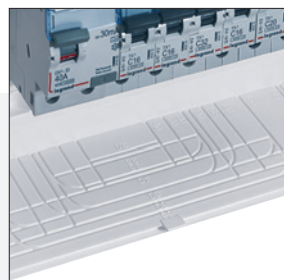

6 TRUNKING FEEDTHROUGH
Cut-out entries for feeding through trunking from the top or bottom, depending on the cabinet position.

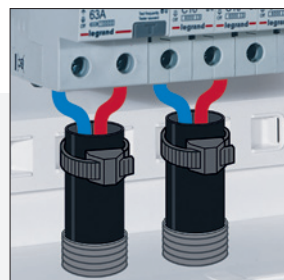

7 CABLE TIE SUPPORTS
Used to optimise cable organisation.



8 KEY-OPERATED LOCK
Cut-out slot on the door for key-operated lock.

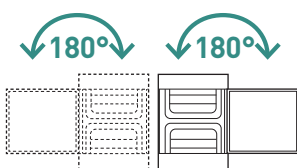

CABINET AND REVERSIBLE DOORS.
DOOR OPENS TO 180°

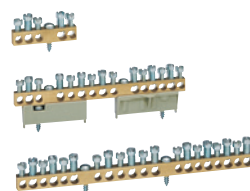

POSSIBILITY TO ACCOMMODATE BARE BRASS TERMINAL BLOCKS (EARTH AND/OR NEUTRAL)



POSSIBILITY TO ADD BARE BRASS TERMINALS TO TERMINAL BLOCK SUPPLIED WITH THE CABINETS

Practibox S surface mounting

cabinets from 4 to 72 modules



Technical characteristics p. 11

Allows to achieve assemblies conform to IEC 61439-3
IP40 IK07
Class II
Plastic material
Supplied with door

Pack	Cat.Nos		Number of rows	Number of modules per row	Total number of modules	Height (mm)	Width (mm)	Depth (mm)
	White door	Smoked Transparent door						
1	1 341 04	1 341 14	1	4	4	216	184	100
1	1 341 08	1 341 18	1	8	8	226	256	100
1	1 351 01	1 351 11	1	12	12	236	328	107
1	1 351 02	1 351 12	2	12	24	386	328	108
1	1 351 03	1 351 13	3	12	36	536	328	108
1	1 351 04	1 351 14	4	12	48	766	328	108
1	1 371 06	1 371 16	1	18	18	236	436	107
1	1 371 07	1 371 17	2	18	36	386	436	108
1	1 371 08	1 371 18	3	18	54	616	436	108
1	1 371 09	1 371 19	4	18	72	766	436	108
1	1 371 05	1 371 15	1	22	22	236	508	107

Cabinets supplied without terminal blocks

Pack	Cat.Nos		Number of rows	Number of modules per row	Total number of modules	Height (mm)	Width (mm)	Depth (mm)
	White door	Smoked Transparent door						
1	1 341 24	1 341 34	1	4	4	216	184	100
1	1 341 28	1 341 38	1	8	8	226	256	100
1	1 351 21	1 351 31	1	12	12	236	328	107
1	1 351 22	1 351 32	2	12	24	386	328	108
1	1 351 23	1 351 33	3	12	36	536	328	108
1	1 351 24	1 351 34	4	12	48	766	328	108
1	1 371 26	1 371 36	1	18	18	236	436	107
1	1 371 27	1 371 37	2	18	36	386	436	108
1	1 371 28	1 371 38	3	18	54	616	436	108
1	1 371 29	1 371 39	4	18	72	766	436	108
1	1 371 25	1 371 35	1	22	22	236	508	107

Cabinets supplied with earth terminal blocks

Pack	Cat.Nos		Number of rows	Number of modules per row	Total number of modules	Height (mm)	Width (mm)	Depth (mm)
	White door	Smoked Transparent door						
1	1 342 04	1 342 14	1	4	4	216	184	100
1	1 342 08	1 342 18	1	8	8	226	256	100
1	1 352 01	1 352 11	1	12	12	236	328	107
1	1 352 02	1 352 12	2	12	24	386	328	108
1	1 352 03	1 352 13	3	12	36	536	328	108
1	1 352 04	1 352 14	4	12	48	766	328	108
1	1 372 06	1 372 16	1	18	18	236	436	107
1	1 372 07	1 372 17	2	18	36	386	436	108
1	1 372 08	1 372 18	3	18	54	616	436	108
1	1 372 09	1 372 19	4	18	72	766	436	108
1	1 372 05	1 372 15	1	22	22	236	508	107

Cabinets supplied with earth and neutral terminal blocks

Practibox S flush-mounting

cabinets for masonry from 4 to 72 modules



Technical characteristics p. 12

Allows to achieve assemblies conform to IEC 61439-3
IP40 IK07
Class II
Plastic material
Supplied with door
For brick and masonry walls
65° fireproof flush-mounting plastic boxes

Pack	Cat.Nos		Number of rows	Number of modules per row	Total number of modules	Height (mm)	Width (mm)	Depth (mm)
	White door	Smoked Transparent door						
1	1 340 04	1 340 14	1	4	4	215	184	100
1	1 340 08	1 340 18	1	8	8	225	256	100
1	1 350 01	1 350 11	1	12	12	235	328	102
1	1 350 02	1 350 12	2	12	24	385	328	103
1	1 350 03	1 350 13	3	12	36	535	328	103
1	1 350 04	1 350 14	4	12	48	765	328	103
1	1 370 06	1 370 16	1	18	18	235	436	102
1	1 370 07	1 370 17	2	18	36	385	436	103
1	1 370 08	1 370 18	3	18	54	615	436	103
1	1 370 09	1 370 19	4	18	72	765	436	103
1	1 370 05	1 370 15	1	22	22	235	508	102

Cabinets supplied without terminal blocks

Pack	Cat.Nos		Number of rows	Number of modules per row	Total number of modules	Height (mm)	Width (mm)	Depth (mm)
	White door	Smoked Transparent door						
1	1 340 44	1 340 54	1	4	4	215	184	100
1	1 340 48	1 340 58	1	8	8	225	256	100
1	1 350 41	1 350 51	1	12	12	235	328	102
1	1 350 42	1 350 52	2	12	24	385	328	103
1	1 350 43	1 350 53	3	12	36	535	328	103
1	1 350 44	1 350 54	4	12	48	765	328	103
1	1 370 46	1 370 56	1	18	18	235	436	102
1	1 370 47	1 370 57	2	18	36	385	436	103
1	1 370 48	1 370 58	3	18	54	615	436	103
1	1 370 49	1 370 59	4	18	72	765	436	103
1	1 370 45	1 370 55	1	22	22	235	508	102

Cabinets supplied with earth terminal blocks

Pack	Cat.Nos		Number of rows	Number of modules per row	Total number of modules	Height (mm)	Width (mm)	Depth (mm)
	White door	Smoked Transparent door						
1	1 341 44	1 341 54	1	4	4	215	184	100
1	1 341 48	1 341 58	1	8	8	225	256	100
1	1 351 41	1 351 51	1	12	12	235	328	102
1	1 351 42	1 351 52	2	12	24	385	328	103
1	1 351 43	1 351 53	3	12	36	535	328	103
1	1 351 44	1 351 54	4	12	48	765	328	103
1	1 371 46	1 371 56	1	18	18	235	436	102
1	1 371 47	1 371 57	2	18	36	385	436	103
1	1 371 48	1 371 58	3	18	54	615	436	103
1	1 371 49	1 371 59	4	18	72	765	436	103
1	1 371 45	1 371 55	1	22	22	235	508	102

Cabinets supplied with earth and neutral terminal blocks

Practibox S flush-mounting cabinets

for dry partitions from 4 to 72 modules



1 340 24



1 340 34



1 350 21



1 350 23



Technical characteristics p. 12

Allows to achieve assemblies conform to IEC 61439-3

IP40 IK07

Class II

Plastic material

Supplied with door

For dry partitions

850° fireproof flush-mounting plastic boxes

Pack	Cat.Nos		Cabinets supplied without terminal blocks					
	White door	Smoked Transparent door	Number of rows	Number of modules per row	Total number of modules	Height (mm)	Width (mm)	Depth (mm)
1	1 340 24	1 340 34	1	4	4	215	184	100
1	1 340 28	1 340 38	1	8	8	225	256	100
1	1 350 21	1 350 31	1	12	12	235	328	102
1	1 350 22	1 350 32	2	12	24	385	328	103
1	1 350 23	1 350 33	3	12	36	535	328	103
1	1 350 24	1 350 34	4	12	48	765	328	103
1	1 370 26	1 370 36	1	18	18	235	436	102
1	1 370 27	1 370 37	2	18	36	385	436	103
1	1 370 28	1 370 38	3	18	54	615	436	103
1	1 370 29	1 370 39	4	18	72	765	436	103
1	1 370 25	1 370 35	1	22	22	235	508	102

Pack	Cat.Nos		Cabinets supplied with earth terminal blocks					
	White door	Smoked Transparent door	Number of rows	Number of modules per row	Total number of modules	Height (mm)	Width (mm)	Depth (mm)
1	1 340 64	1 340 74	1	4	4	215	184	100
1	1 340 68	1 340 78	1	8	8	225	256	100
1	1 350 61	1 350 71	1	12	12	235	328	102
1	1 350 62	1 350 72	2	12	24	385	328	103
1	1 350 63	1 350 73	3	12	36	535	328	103
1	1 350 64	1 350 74	4	12	48	765	328	103
1	1 370 66	1 370 76	1	18	18	235	436	102
1	1 370 67	1 370 77	2	18	36	385	436	103
1	1 370 68	1 370 78	3	18	54	615	436	103
1	1 370 69	1 370 79	4	18	72	765	436	103
1	1 370 65	1 370 75	1	22	22	235	508	102

Pack	Cat.Nos		Cabinets supplied with earth and neutral terminal blocks					
	White door	Smoked Transparent door	Number of rows	Number of modules per row	Total number of modules	Height (mm)	Width (mm)	Depth (mm)
1	1 341 64	1 341 74	1	4	4	215	184	100
1	1 341 68	1 341 78	1	8	8	225	256	100
1	1 351 61	1 351 71	1	12	12	235	328	102
1	1 351 62	1 351 72	2	12	24	385	328	103
1	1 351 63	1 351 73	3	12	36	535	328	103
1	1 351 64	1 351 74	4	12	48	765	328	103
1	1 371 66	1 371 76	1	18	18	235	436	102
1	1 371 67	1 371 77	2	18	36	385	436	103
1	1 371 68	1 371 78	3	18	54	615	436	103
1	1 371 69	1 371 79	4	18	72	765	436	103
1	1 371 65	1 371 75	1	22	22	235	508	102

Practibox S

accessories



4 018 56



0 016 60

Pack	Cat.Nos	Accessories
1	1 341 00	Key lock Can be mounted on all sizes of flush and surface mounting enclosures
1	1 341 02	Horizontal and vertical joining kit for flush-mounting enclosure
1	4 018 56	Set of 4 wall fixing lugs for XL ³ 125 and Practibox S surface mounting cabinets
		Blanking plates
20	0 016 60	Separable per module or 1/2 module
10	0 016 62	5 modules
10	0 016 64	13 modules
		18 modules

Practibox S

terminal blocks

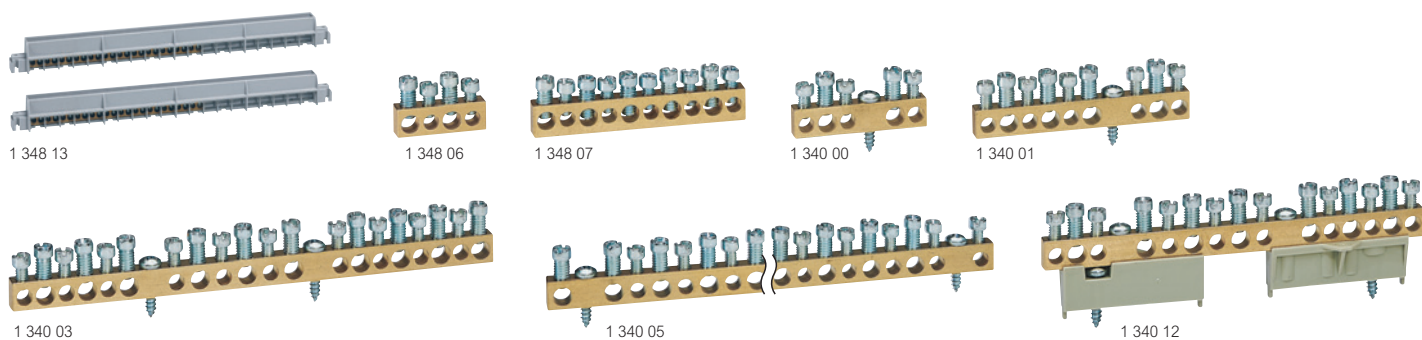

Conform to IEC 60998-2-1

Pack	Cat.Nos	Earth terminal blocks
10	1 348 00	Brass terminal block with isolated support For 4 modules cabinets 1 x (2x16 ² + 2x10 ²); lcc: 6 kA
10	1 348 01	For 8 modules cabinets 1 x (3x16 ² + 3x10 ²); lcc: 6 kA
10	1 348 02	For 12 modules flush-mounting cabinets 1 x (12x16 ² + 12x10 ²); lcc: 6 kA
10	1 348 03	For 12 modules surface mounting cabinets 1 x (12x16 ² + 12x10 ²); lcc: 6 kA
10	1 348 04	For 1 row 18 modules flush-mounting cabinets 1 x (1x25 ² + 12x16 ²); lcc: 10 kA
10	1 348 05	For 18 modules cabinets: 1 to 4 rows surface mounting version and 2 to 4 rows flush-mounting version 1 x (1x25 ² + 26x16 ²); lcc: 10 kA
Earth and neutral terminal block		
10	1 348 10	Brass terminal block with isolated support For 4 modules cabinets 2 x (2x16 ² + 2x10 ²); lcc: 6 kA
10	1 348 11	For 8 modules cabinets 2 x (3x16 ² + 3x10 ²); lcc: 6 kA
10	1 348 12	For 12 modules flush-mounting cabinets 2 x (12x16 ² + 12x10 ²); lcc: 6 kA
10	1 348 13	For 12 modules surface mounting cabinets 2 x (12x16 ² + 12x10 ²); lcc: 6 kA
10	1 348 14	For 1 row 18 modules flush-mounting cabinets 2 x (1x25 ² + 12x16 ²); lcc: 10 kA
10	1 348 15	For 18 modules cabinets: 1 to 4 rows surface mounting version and 2 to 4 rows flush-mounting version 2 x (1x25 ² + 26x16 ²); lcc: 10 kA
10	1 348 16	For 22 modules cabinets 2 x (1x25 ² + 12x16 ²); lcc: 10 kA

Pack	Cat.Nos	Additional bare terminal blocks
		Bare brass terminal blocks to be integrated into Practibox S earth or earth & neutral terminal blocks Cat.Nos 1 348 00/01/02/03/10/11/12/13
10	1 348 06	4 holes 2x16 ² + 2x10 ² ; lcc: 6 kA
10	1 348 07	10 holes 5x16 ² + 5x10 ² ; lcc: 6 kA
Screw fixing bare terminal blocks		
Bare brass terminal blocks, to be fixed directly at the back of the Practibox S cabinets Supplied with fixing screws		
Earth terminal blocks		
10	1 340 00	5 holes 2x16 ² + 3x10 ² ; lcc: 6 kA
10	1 340 01	9 holes 4x16 ² + 5x10 ² ; lcc: 6 kA
10	1 340 02	15 holes 7x16 ² + 8x10 ² ; lcc: 6 kA
10	1 340 03	20 holes 10x16 ² + 10x10 ² ; lcc: 6 kA
10	1 340 05	40 holes 20x16 ² + 20x10 ² ; lcc: 6 kA
Neutral terminal blocks		
10	1 340 10	5 holes 2x16 ² + 3x10 ² ; lcc: 6 kA
10	1 340 11	9 holes 4x16 ² + 5x10 ² ; lcc: 6 kA
10	1 340 12	15 holes 7x16 ² + 8x10 ² ; lcc: 6 kA
10	1 340 13	20 holes 10x16 ² + 10x10 ² ; lcc: 6 kA
10	1 340 15	40 holes 20x16 ² + 20x10 ² ; lcc: 6 kA

Practibox S

surface mounting cabinets - technical characteristics

Composition of distribution cabinets from 4 to 72 modules

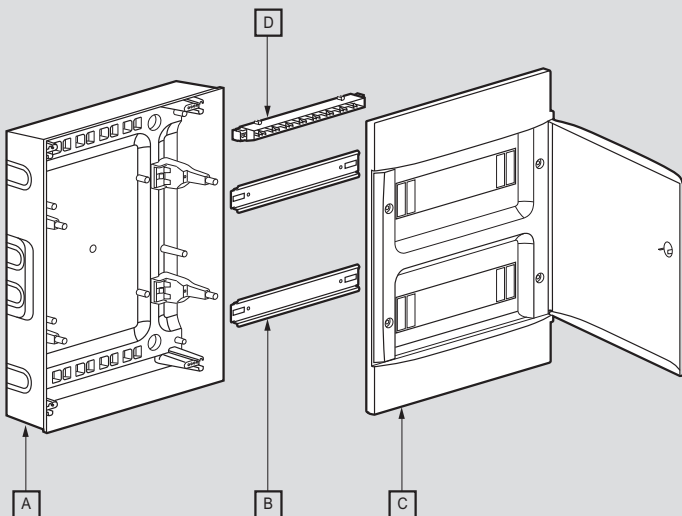

A: surface mounting box
 B: rail
 C: removable faceplate with white or transparent door
 D: terminal blocks (depending on the cabinet version)

Dimensions

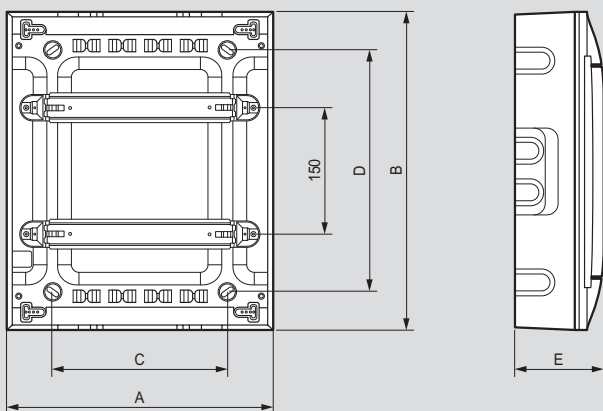

Cat.Nos	Dimensions (mm)				
	A	B	C	D	E
1 341 04/14/24/34 / 1 342 04/14	184	216	72	120	100
1 341 08/18/28/38 / 1 342 08/18	256	226	150	120	100
1 351 01/11/21/31 / 1 352 01/11	328	236	210	140	107
1 351 02/12/22/32 / 1 352 02/12	328	386	210	290	108
1 351 03/13/23/33 / 1 352 03/13	328	536	210	440	108
1 351 04/14/24/34 / 1 352 04/14	328	766	210	600	108
1 371 06/16/26/36 / 1 372 06/16	436	236	320	140	107
1 371 07/17/27/37 / 1 372 07/17	436	386	320	290	108
1 371 08/18/28/38 / 1 372 08/18	436	616	320	470	108
1 371 09/19/29/39 / 1 372 09/19	436	766	320	620	108
1 371 05/15/25/35 / 1 372 05/15	508	236	390	140	107

Number of blanking plates supplied per enclosure

Cat.Nos	Number of blanking plates 5 modules
1 341 04/14/24/34 / 1 342 04/14	-
1 341 08/18/28/38 / 1 342 08/18	-
1 351 01/11/21/31 / 1 352 01/11	-
1 351 02/12/22/32 / 1 352 02/12	1
1 351 03/13/23/33 / 1 352 03/13	1
1 351 04/14/24/34 / 1 352 04/14	1
1 371 06/16/26/36 / 1 372 06/16	1
1 371 07/17/27/37 / 1 372 07/17	1
1 371 08/18/28/38 / 1 372 08/18	2
1 371 09/19/29/39 / 1 372 09/19	2
1 371 05/15/25/35 / 1 372 05/15	1

Number of connections per earth terminal block (supplied with enclosure)

Cat.Nos	Earth terminal blocks Screw connection		
	6 - 25 mm ²	1.5 - 16 mm ²	1.5 - 10 mm ²
1 341 24/34	-	2	2
1 341 28/38	-	3	3
1 351 21/31	-	5	5
1 351 22/32	-	8	8
1 351 23/33	-	12	12
1 351 24/34	-	16	16
1 371 25/35	-	8	8
1 371 26/36	1	12	-
1 371 27/37	1	21	-
1 371 28/38	1	34	-
1 371 29/39	1	34	-

Number of connections per neutral and earth terminal block (supplied with enclosure)

Cat.Nos	Neutral terminal blocks Screw connection			Earth terminal blocks Screw connection		
	6 - 25 mm ²	1.5 - 16 mm ²	1.5 - 10 mm ²	6 - 25 mm ²	1.5 - 16 mm ²	1.5 - 10 mm ²
1 342 04/14	-	2	2	-	2	2
1 342 08/18	-	3	3	-	3	3
1 352 01/11	-	5	5	-	5	5
1 352 02/12	-	8	8	-	8	8
1 352 03/13	-	12	12	-	12	12
1 352 04/14	-	16	16	-	16	16
1 372 05/15	-	8	8	-	8	8
1 372 06/16	1	12	-	1	12	-
1 372 07/17	1	21	-	1	21	-
1 372 08/18	1	34	-	1	34	-
1 372 09/19	1	34	-	1	34	-

Practibox S

flush-mounting cabinets for masonry and dry partitions - technical characteristics

Composition of distribution cabinets from 4 to 72 modules

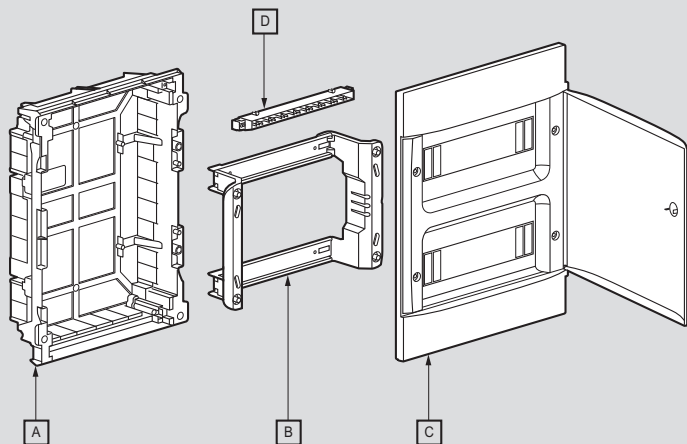

A: flush-mounting box for masonry or dry partitions
B: removable chassis with leveling system

C: removable faceplate with white or transparent door
D: terminal blocks (depending on the cabinet version)

Dimensions

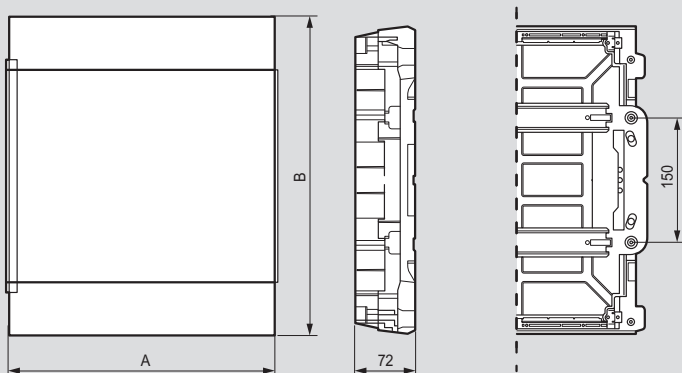

Réf.	Dimensions (mm)			
	A	B	C	D
Cabinets for masonry				
1 340 04/14/44/54 / 1 341 44/54	184	215	166	215
1 340 08/18/48/58 / 1 341 48/58	256	225	238	225
1 350 01/11/41/51 / 1 351 41/51	328	235	310	235
1 350 02/12/42/52 / 1 351 42/52	328	385	310	385
1 350 03/13/43/53 / 1 351 43/53	328	535	310	535
1 350 04/14/44/54 / 1 351 44/54	328	765	310	685
1 370 06/16/46/56 / 1 371 46/56	436	235	418	235
1 370 07/17/47/57 / 1 371 47/57	436	385	418	385
1 370 08/18/48/58 / 1 371 48/58	436	615	418	535
1 370 09/19/49/59 / 1 371 49/59	436	765	418	685
1 370 05/15/45/55 / 1 371 45/55	508	235	490	235
Cabinets for dry partitions				
1 340 24/34/64/74 / 1 341 64/74	184	215	146	205
1 340 28/38/68/78 / 1 341 68/78	256	225	218	215
1 350 21/31/61/71 / 1 351 61/71	328	235	290	225
1 350 22/32/62/72 / 1 351 62/72	328	385	290	375
1 350 23/43/63/73 / 1 351 63/73	328	535	290	525
1 350 24/34/64/74 / 1 351 64/74	328	765	290	675
1 370 26/36/66/76 / 1 371 66/76	436	235	398	225
1 370 27/37/67/77 / 1 371 67/77	436	385	398	375
1 370 28/38/68/78 / 1 371 68/78	436	615	398	525
1 370 29/39/69/79 / 1 371 69/79	436	765	398	675
1 370 25/35/65/75 / 1 371 65/75	508	235	470	225

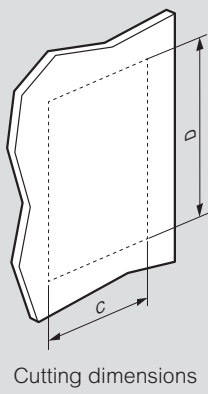

Cutting dimensions

Number of blanking plates supplied per enclosure

Cat.Nos	Number of blanking plates 5 modules
1 340 04/14/24/34/44/54/64/74	-
1 340 08/18/28/38/48/58/68/78	-
1 341 44/54/64/74	-
1 341 48/58/68/78	-
1 350 01/11/21/31/41/51/61/71	-
1 350 02/12/22/32/42/52/62/72	1
1 350 03/13/23/33/43/53/63/73	1
1 350 04/14/24/34/44/54/64/74	1
1 351 41/51/61/71	-
1 351 42/52/62/72	1
1 351 43/53/63/73	1
1 351 44/54/64/74	1
1 370 05/15/25/35/45/55/65/75	1
1 370 06/16/26/36/46/56/66/76	1
1 370 07/17/27/37/47/57/67/77	1
1 370 08/18/28/38/48/58/68/78	2
1 370 09/19/29/39/49/59/69/79	2
1 371 46/56/66/76	1
1 371 47/57/67/77	1
1 371 48/58/68/78	2
1 371 49/59/69/79	2

Number of connections per earth terminal block (supplied with enclosure)

Cat.Nos	Earth terminal blocks Screw connection		
	6 - 25 mm ²	1.5 - 16 mm ²	1.5 - 10 mm ²
1 340 44/54/64/74	-	2	2
1 340 48/58/68/78	-	3	3
1 350 41/51/61/71	-	5	5
1 350 42/52/62/72	-	8	8
1 350 43/53/63/73	-	12	12
1 350 44/54/64/74	-	16	16
1 350 45/55/65/75	-	8	8
1 370 46/56/66/76	1	12	-
1 370 47/57/67/77	1	21	-
1 370 48/58/68/78	1	34	-
1 370 49/59/69/79	1	34	-

Number of connections per neutral and earth terminal block (supplied with enclosure)

Cat.Nos	Neutral terminal blocks Screw connection			Earth terminal blocks Screw connection		
	6 - 25 mm ²	1.5 - 16 mm ²	1.5 - 10 mm ²	6 - 25 mm ²	1.5 - 16 mm ²	1.5 - 10 mm ²
1 341 44/54/64/74	-	2	2	-	2	2
1 341 48/58/68/78	-	3	3	-	3	3
1 351 41/51/61/71	-	5	5	-	5	5
1 351 42/52/62/72	-	8	8	-	8	8
1 351 43/53/63/73	-	12	12	-	12	12
1 351 44/54/64/74	-	16	16	-	16	16
1 371 45/55/65/75	1	16	-	1	16	-
1 371 46/56/66/76	1	12	-	1	12	-
1 371 47/57/67/77	1	21	-	1	21	-
1 371 48/58/68/78	1	34	-	1	34	-
1 371 49/59/69/79	1	34	-	1	34	-

Practibox S

terminal blocks - technical characteristics

Number of connections per earth terminal block

Cat.Nos	Earth terminal blocks Screw connection		
	6 - 25 mm ²	1.5 - 16 mm ²	1.5 - 10 mm ²
1 348 00	-	2	2
1 348 01	-	3	3
1 348 02	-	12	12
1 348 03	-	12	12
1 348 04	1	12	-
1 348 05	1	26	-

Number of connections per neutral and earth terminal block

Cat.Nos	Neutral terminal blocks Screw connection			Earth terminal blocks Screw connection		
	6 - 25 mm ²	1.5 - 16 mm ²	1.5 - 10 mm ²	6 - 25 mm ²	1.5 - 16 mm ²	1.5 - 10 mm ²
1 348 10	-	2	2	-	2	2
1 348 11	-	3	3	-	3	3
1 348 12	-	12	12	-	12	12
1 348 13	-	12	12	-	12	12
1 348 14	1	12	-	1	12	-
1 348 15	1	26	-	1	26	-
1 348 16	1	12	-	1	12	-

Number of connections per additional bare terminal block

Cat.Nos	Earth terminal blocks		
	6 - 25 mm ²	1.5 - 16 mm ²	1.5 - 10 mm ²
1 348 06	-	2	2
1 348 07	-	5	5

Number of connections per screw fixing bare terminal block

Cat.Nos	Earth or neutral terminal blocks Screw connection		
	6 - 25 mm ²	1.5 - 16 mm ²	1.5 - 10 mm ²
1 340 00/10	-	2	3
1 340 01/11	-	4	5
1 340 02/12	-	7	8
1 340 03/13	-	10	10
1 340 05/15	-	20	20



FOLLOW US ON

@ website: www.legrand.eg

f leggrand

@ leggrandegypt



EMB Electrical Industries S.A.E.

Headquarter office

Pyramids Heights Office Park
KM 22 Cairo - Alex. desert road
Building 1B, 12556
Tel.: +202 3536 0000
Fax: +202 3536 0001
www.legrand.eg