

BRINGS VALUE IN
QUALITY, TECHNOLOGY
AND ABOVE ALL
ITALIAN DESIGN



2022

Commercial & Residential **Solutions**

Product Catalogue

bticino



بتشينو في مصر

بتشينو شركة إيطالية رائدة في صناعة المنتجات الكهربائية و الرقمية في العالم . وهي إحدى الشركات التابعة لمجموعة ليجراند الفرنسية المتواجدة في أكثر من ٨٠ دولة حول العالم . وقد تم إنشاء مصنع بتشينو مصر «EMB» عام ١٩٨٦ في مدينة السادات ، يعمل به أكثر من ٥٠٠ عامل ومهندس بأستخدام أحدث الآليات التكنولوجية و إختبارات الجودة العالمية ، وذلك لتقديم منتجات علي أعلي مستوي من الجودة والامان .

وقد تم إنضمام إي إم بي للصناعات الكهربائية ش.م.م. لمبادرة" بكل فخر صنع في مصر". تعمل المبادرة تحت إشراف مركز تحديث الصناعة (IMC) و وزارة التجارة والصناعة. وتهدف إلى دعم المنتجات المحلية والاقتصاد الوطني عن طريق تمكين المنتجات المصرية بجودتها العالية و تشجيع المصريين على شراء منتجات محلية عالية الجودة.

SAFETY FIRST



Your safety is our main concern . We protect You and your family every day from electric hazzards.

UNIVERSAL SOLUTION



More than 300 functionalities to cover all your lighting , safety , date Communicathion energy saving needs.

COMFORT & PEACE OF MIND



Sophisticated yet easy to use devices such as sensors and dimmers , will allow you to take complete control over your home , making your life easier than ever.

PROUD TO BE THE
TRUSTED WORLD-WIDE BRAND
FOR MANUFACTURING HIGH QUALITY
PRODUCTS WITH THE FINEST DESIGN .

PRODUCTS

CLASSIA	04
MATIX EDGE	13
SOLIDA	23
FORMA MAX	30
MAGIC	38
MCB	40
SAFETY BREAKER	44
FUSE SWITCH	46
COMPLIMENTARY PRODUCTS	48

Residential Solution By BTicino
A Complete Range Of Products



- SAFETY BREAKER



- FUSE SWITCH



- CONTROLS



- BELL CONTROLS



- TV JACKS



- MCB & RCBO



- SOCKETS



- SHUTTER CONTROL



CLASSIA

**SIMPLER
SMARTER
THAN EVER**

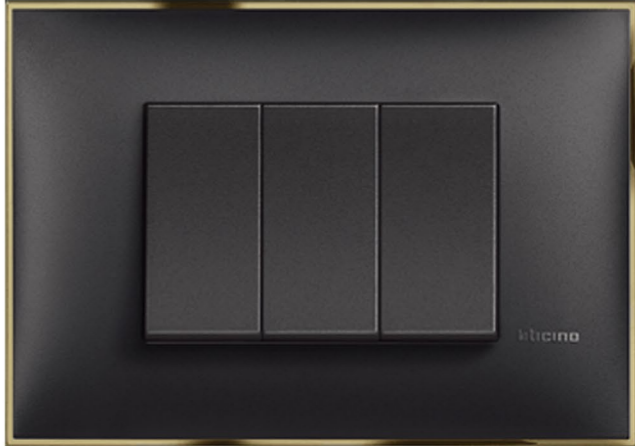

SIMPLE SHAPE



A modern pure shape, defined by an accurate outline which contrasts with a gently curved surface. The frame gives a unique touch to your switch.

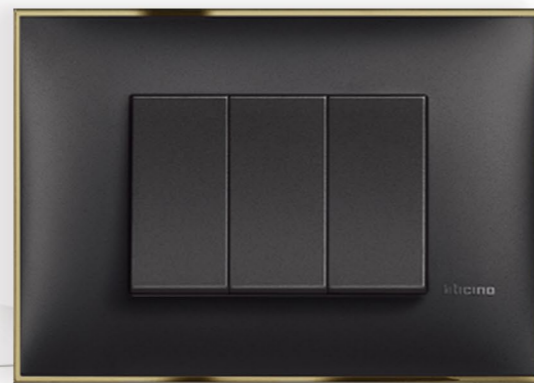

accurate outline contrasts with a gently curved volume



Slightly curved push button

BASICS

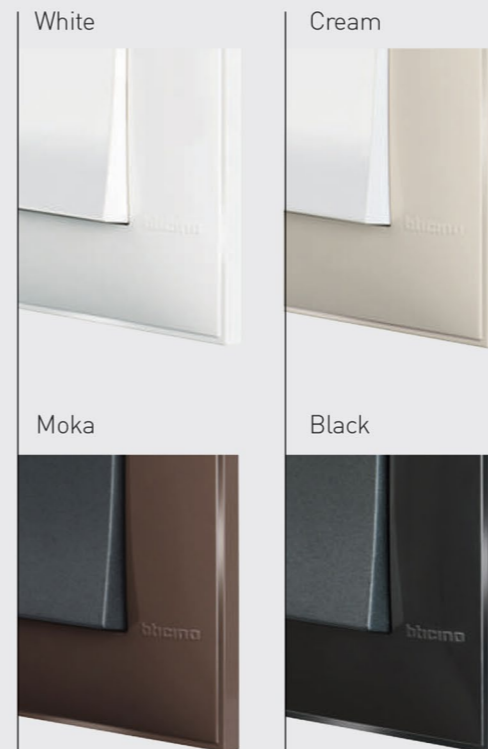

FRAMES

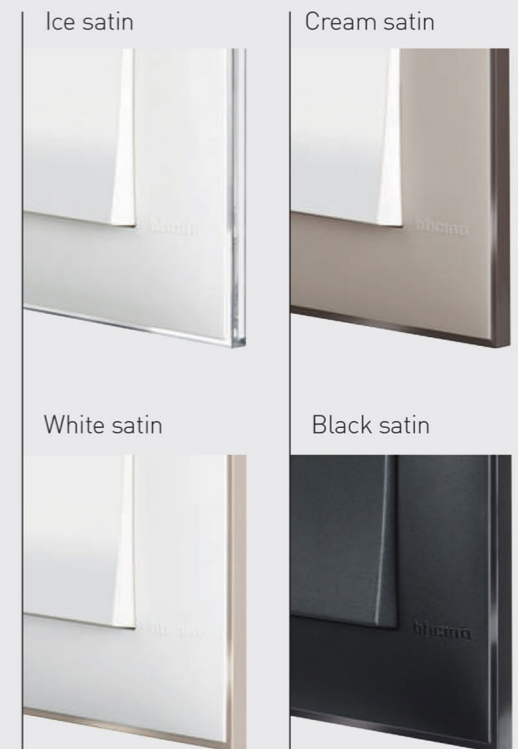

FINISHES

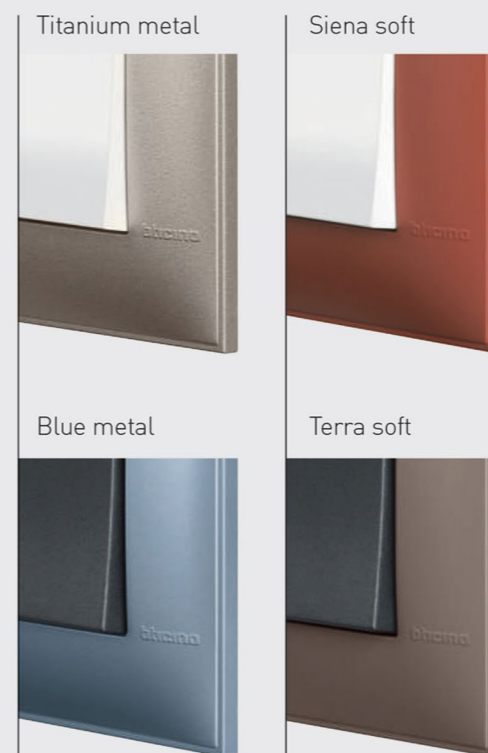

ACCENTS

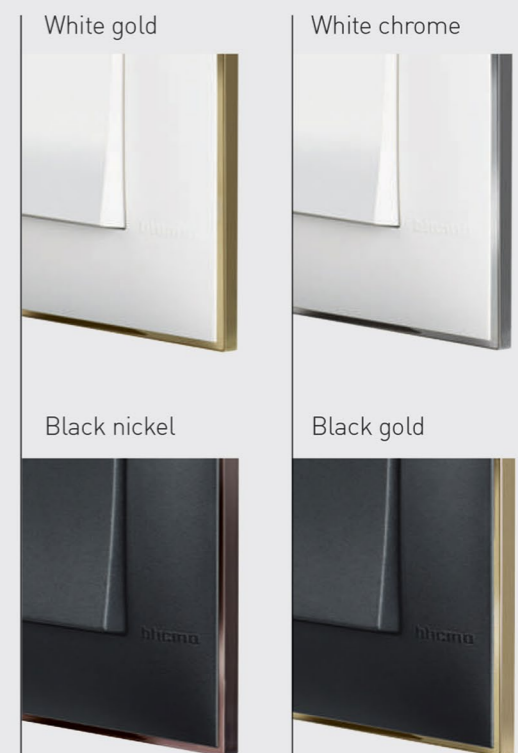

CLASSIA SWITCHES



ITEM	ONE-WAY SWITCHES
<input type="checkbox"/> RW4001	1P 10 AX - 250 Va.c. - 1 module - white
<input checked="" type="checkbox"/> RG4001	as above - black
<input type="checkbox"/> RW4001L	1P 10 AX - 250 Va.c. - lightable with led lamp 230 V included - 1 module - white
<input checked="" type="checkbox"/> RG4001L	as above - black
<input type="checkbox"/> RW4001M2	1P 10 AX - 250 Va.c. - 2 modules - white
<input checked="" type="checkbox"/> RG4001M2	as above - black
<input type="checkbox"/> RW4001M2L	1P 10 AX - 250 Va.c. - lightable with led lamp 230 V included - 2 modules - white
<input checked="" type="checkbox"/> RG4001M2L	as above - black
<input type="checkbox"/> RW4001LS	1P 16 AX - 250 Va.c. - lightable with led lamp 230 V included - 1 module - boiler symbol - white
<input checked="" type="checkbox"/> RG4001LS	as above - black
<input type="checkbox"/> RW4001LP	1P 16 AX - 250 Va.c. - lightable with led lamp 230 V included - 1 module - heater symbol - white
<input checked="" type="checkbox"/> RG4001LP	as above - black
<input type="checkbox"/> RW4001LR	1P 10 AX - 250 Va.c. - lightable with led lamp 230 V included - 1 module - fan symbol - white
<input checked="" type="checkbox"/> RG4001LR	as above - black
<input type="checkbox"/> RW4001LA	1P 10 AX - 250 Va.c. - lightable with led lamp 230 V included - 1 module - lamp symbol - white
<input checked="" type="checkbox"/> RG4001LA	as above - black
<input type="checkbox"/> RW4002L	2P 16 AX - 250 Va.c. - lightable with led lamp 230 V included - 1 module - white
<input checked="" type="checkbox"/> RG4002L	as above - black

ITEM	TWO-WAY SWITCHES
<input type="checkbox"/> RW4003	1P 10 AX - 250 Va.c. - 1 module - white
<input checked="" type="checkbox"/> RG4003	as above - black
<input type="checkbox"/> RW4003L	1P 10 AX - 250 Va.c. - lightable with led lamp 230 V included - 1 module - white - 1 module - white
<input checked="" type="checkbox"/> RG4003L	as above - black
<input type="checkbox"/> RW4003M2	1P 10 AX - 250 Va.c. - 2 modules - white
<input checked="" type="checkbox"/> RG4003M2	as above - black
<input type="checkbox"/> RW4003M2L	1P 10 AX - 250 Va.c. - lightable with led lamp 230 V included - 2 modules - white
<input checked="" type="checkbox"/> RG4003M2L	as above - black

ITEM	FOUR-WAY SWITCHES
<input type="checkbox"/> RW4004	intermediate switch 10 AX - 250 Va.c. - 1 module - white
<input checked="" type="checkbox"/> RG4004	as above - black
<input type="checkbox"/> RW4004L	intermediate switch 10 AX - 250 Va.c. - lightable with led lamp 230 V included - 1 module - white
<input checked="" type="checkbox"/> RG4004L	as above - black
<input type="checkbox"/> RW4004M2	intermediate switch 10 AX - 250 Va.c. - 2 modules - white
<input checked="" type="checkbox"/> RG4004M2	as above - black
<input type="checkbox"/> RW4004M2L	intermediate switch 10 AX - 250 Va.c. - lightable with led lamp 230 V included - 2 modules - white
<input checked="" type="checkbox"/> RG4004M2L	as above - black

CLASSIA SOCKET OUTLETS

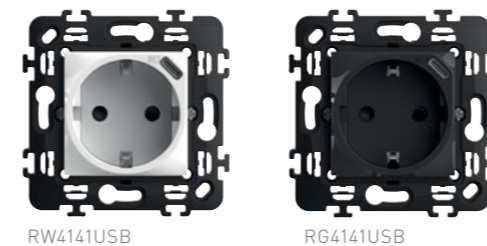
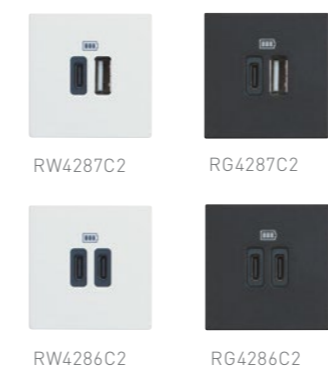

ITEM	ITALIAN STANDARD
<input type="checkbox"/> RW4180	2P+E 16 A 250 Va.c. socket - center distance 19 mm and 26mm - shielded tulip contacts - for plugs 2 P and 2 P+E 10 and 16 A Italian standard - white
<input checked="" type="checkbox"/> RG4180	as above - black
<input type="checkbox"/> R4180R	as above - Red
<input type="checkbox"/> RW4113	socket 2P+E 10A 250 Va.c. - type earth side contacts - shielded socket contacts - white
<input checked="" type="checkbox"/> RG4113	as above - black
<input type="checkbox"/> RW4140A16	socket 2P+E 10A and 16A 250 Va.c. 19 mm and 26 mm center distance, 2-center socket configuration protected socket contacts; earth side contacts for German standard plugs; suitable for Italian standard plugs 2P and 2P+E 10/16A, German standard plugs 2P+E 16A - white
<input checked="" type="checkbox"/> RG4140A16	as above - black
<input type="checkbox"/> R4140A16R	as above - red

ITEM	EURO-AMERICAN STANDARD
<input type="checkbox"/> RW4125	socket 2P 16 A 127/250 Va.c. - shielded holes - white
<input checked="" type="checkbox"/> RG4125	as above - black

ITEM	USB CHARGER
<input type="checkbox"/> RW4287C2	5 Vdc USB charger TYPE A and C for quick charge of one single electronic device (mobile phones, smartphones, tablets or similar) up to 3000 mA or simultaneous charging of two devices up to 1500 mA - 110±230 Va.c. 50±60 Hz power supply - 2 modules - white
<input checked="" type="checkbox"/> RG4287C2	as above - black
<input type="checkbox"/> RW4286C2	5 Vdc USB charger TYPE C for quick charge of one single electronic device (mobile phones, smartphones, tablets or similar) up to 3000 mA or simultaneous charging of two devices up to 1500 mA - 110±230 Va.c. 50±60 Hz power supply - 2 modules - white
<input checked="" type="checkbox"/> RG4286C2	as above - black

ITEM	USB SOCKETS
<input type="checkbox"/> RW4141USB	German standard electric socket with integrated USB charger. Socket 2 P+E 16 A 250 VA - protected tulip contacts - side earth contact. 5 Vdc type C USB charger for charging electronic devices up to 1,500 mA. 2 modules - white
<input checked="" type="checkbox"/> RG4141USB	as above - black

CLASSIA SOCKET OUTLETS



RW4141



RG4141



R4141A



R4141R



R4141V



RW4139

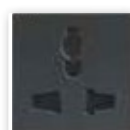

RG4139

ITEM	GERMAN STANDARD
<input type="checkbox"/> RW4141	socket 2P+E 16A 250 Va.c. - socket with earth side contacts - shielded tulip contacts - white
<input checked="" type="checkbox"/> RG4141	as above - black
<input checked="" type="checkbox"/> R4141A	as above - orange
<input checked="" type="checkbox"/> R4141R	as above - red
<input checked="" type="checkbox"/> R4141V	as above - green

ITEM	MULTISTANDARD SOCKETS
<input type="checkbox"/> RW4139	socket 2P+E 5/6/10/13 A 250 Va.c. and 127 Va.c. multistandard - 5 A and 13 A = BS std.; 6 A = Indian std., 10 A = European std. - white
<input checked="" type="checkbox"/> RG4139	as above - black

CLASSIA TELEPHONE AND DATA SOCKETS



RW4258RJ11



RG4258RJ11



RW4279C5E



RG4279C5E



RW4279C6



RG4279C6



RW4279C6AS



RG4279C6AS

ITEM	RJ CONNECTORS
<input type="checkbox"/> RW4258RJ11	RJ11 connector type K10 - 1 module - white
<input checked="" type="checkbox"/> RG4258RJ11	as above - black
<input type="checkbox"/> RW4279C5E	RJ45 toolless UTP cat5E - 1 module - white
<input checked="" type="checkbox"/> RG4279C5E	as above - black
<input type="checkbox"/> RW4279C6	RJ45 toolless UTP cat6 - 1 module - white
<input checked="" type="checkbox"/> RG4279C6	as above - black
<input type="checkbox"/> RW4279C6	RJ45 toolless UTP cat6 - 1 module - white
<input checked="" type="checkbox"/> RG4279C6AS	as above - black

CLASSIA TV SOCKETS



RW4202D



RG4202D



RW4202F



RG4202F

ITEM	TV SOCKETS
<input type="checkbox"/> RW4202D	star coaxial socket for single-user aerial systems, also remote powered and centralised, and single-user / centralised satellite systems with current and signal transfer for channels selection; shielded connection clamps with captive screws - Ø 9.5 mm; male connector - 1 module - white
<input checked="" type="checkbox"/> RG4202D	as above - black
<input type="checkbox"/> RW4202F	type-F coaxial socket - impedance 75 ohm - screw hook 1 module - white
<input checked="" type="checkbox"/> RG4202F	as above - black

CLASSIA DIMMERS



RW4402



RG4402



RW4411



RG4411

ITEM	DIMMER
<input type="checkbox"/> RW4402	rotary dimmer 40 - 400 W 230 Va.c. - 2 modules - white
<input checked="" type="checkbox"/> RG4402	as above - black
<input type="checkbox"/> RW4411	universal dimmer (resistive - inductive, capacitive, fluorescent compact and dimmer LEDs) - 150/200/400 W with electronic protection - 2 modules - white
<input checked="" type="checkbox"/> RG4411	as above - black

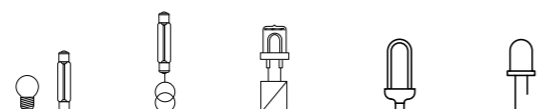

Loads								
Item	Type	Range (Va.c.)	supply std	Incandescents and hologens	Halogens with ferromagnetic transformer	Halogens with electronic transformer	Dimmerable compact fluorescents	Dimmerable lead lamps
RW4402 RG4402	Resistive	230 50	230 Va.c.	40 ÷ 400 W				
RW4411 RG4411	Universal	100 ÷ 240 50 ÷ 60	230 Va.c. 100 Va.c.	3 ÷ 200 W 3 ÷ 400 W	3 ÷ 200 VA 3 ÷ 400 VA	3 ÷ 200 VA 3 ÷ 400 VA	3 ÷ 75 W 3 ÷ 150 W	3 ÷ 75 W 3 ÷ 150 W

CLASSIA OPTICAL AND ACOUSTIC SIGNALLINGS



RW4351V230



RG4351V230



RW4356V230



RG4356V230

ITEM	BELLS AND BUZZERS
<input type="checkbox"/> RW4351V230	bronze bell 230 Va.c. 8 VA - 1 module - white
<input checked="" type="checkbox"/> RG4351V230	as above - black
<input type="checkbox"/> RW4356V230	bronze 230 Va.c. 8 VA - 1 module - white
<input checked="" type="checkbox"/> RG4356V230	as above - black

CLASSIA BLANKING MODULES



RW4950



RG4950

ITEM	BLANKING MODULES AND OUTPUTS
<input type="checkbox"/> RW4950	blank plate - 1 module - white
<input checked="" type="checkbox"/> RG4950	as above - black

COVER PLATES: TABLE FOR SELECTING CODE AREA ITALIAN INSTALLATION SYSTEM

SUPPORTS

BASICS

<input type="checkbox"/> White	R4803RW
<input type="checkbox"/> Cream	R4803CR
<input type="checkbox"/> Moka	R4803MK
<input checked="" type="checkbox"/> Black	R4803BC

FRAMES

<input type="checkbox"/> Ice satin	R4803ES
<input type="checkbox"/> Cream satin	R4803CS
<input type="checkbox"/> White satin	R4803WS
<input checked="" type="checkbox"/> Black satin	R4803BG

FINISHES

<input type="checkbox"/> Titanium metal	R4803TM
<input type="checkbox"/> Siena soft	R4803SF
<input type="checkbox"/> Blue metal	R4803LM
<input type="checkbox"/> Terra soft	R4803TF

ACCENTS

<input type="checkbox"/> White gold	R4803WD
<input type="checkbox"/> White chrome	R4803WR
<input checked="" type="checkbox"/> Black nickel	R4803BH
<input checked="" type="checkbox"/> Black gold	R4803BD

FRAME



R4703

MATIX EDGE INNOVATIVE

DESIGN, COLOURS,
AND FUNCTIONS

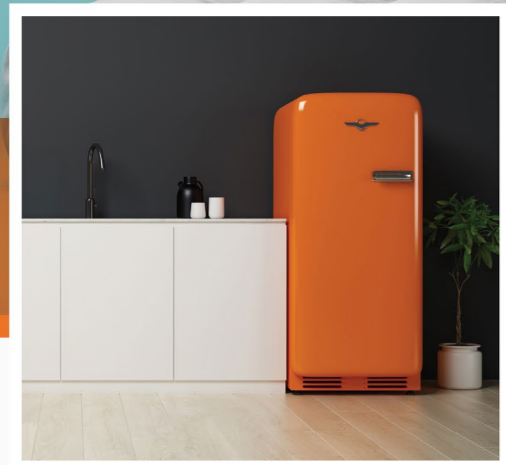

MATIX EDGE

**BEYOND
THE EDGE OF
EXPECTATIONS**

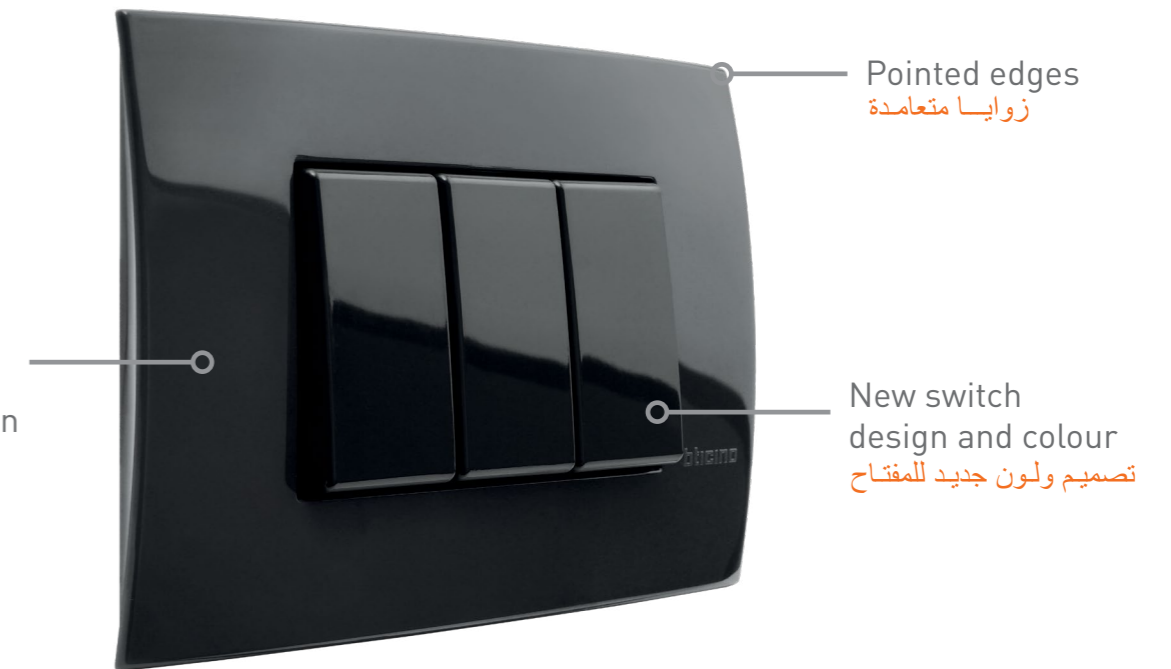

Pointed edges
زوايا متعامدة

New thinner,
curvy, & colorful
cover plate design
تصميم جديد للوجه

New switch
design and colour
تصميم ولون جديد للمفتاح

COVER PLATE DESIGN

Pure lines flowing into a slightly curved surface convey all the typical lightness of contemporary design by BTicino. The harmony of the subtle but curved profile produces a particularly outstanding effect. The result is a rational design, essential and clean where every detail expresses quality.





NEW DESIGN AND COLOUR OF THE SWITCHES

25 colours of cover plates,
split into 3 families:

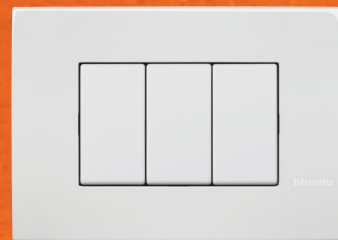

NEUTRAL
Perfect colour match between
cover plate and control.



METALS
Metal finishes for a light point
with a bright and glossy look.



COLOURS
Strong and bright colours,
suitable for environments with character.

BASIC CONTROL DEVICES

مفاتيح التحكم الاساسيه



AM5001E AM5001LE AM5001/2E AM5003/2E AM5003E AM5003LE AM5003/2E AM5005E AM5005LE AM5011E AM5011LE AM5011/32 AM5011/32E AM5005LLE A5086 AG5001E AG5003E AG5005E AG5001/2E AG5003/2E AG5005LBE AG5011E

ITEM	ONE-WAY SWITCHES
<input type="checkbox"/> AM5001E <input type="checkbox"/> A5001E <input type="checkbox"/> AG5001E	1P 16 AX - 250 Va.c.
<input type="checkbox"/> AM5001LE <input type="checkbox"/> A5001LE <input type="checkbox"/> AG5001LE	1P 16 AX - 250 Va.c. - Optional add on lightable with led lamp LN4742V230 - LN4742V230V - device with backlight clearly visible even in daylight and in well-it
<input type="checkbox"/> AM5001/2E <input type="checkbox"/> A5001/2E <input type="checkbox"/> AG5001/2E	1P 16 AX - 250 Va.c. - 2 modules
<input type="checkbox"/> AM5011E <input type="checkbox"/> A5011E <input type="checkbox"/> AG5011E	2P 16 AX - 250 Va.c.
<input type="checkbox"/> AM5011/32 <input type="checkbox"/> A5011/32 <input type="checkbox"/> AG5011/32	2P 32 A - 250 Va.c.
ITEM	INTERMEDIATE SWITCHES - CHANGEOVER SWITCHES
<input type="checkbox"/> AM5012E <input type="checkbox"/> A5012E <input type="checkbox"/> AG5012E	intermediate switch 16 AX - 250 Va.c.
<input type="checkbox"/> AM5086 <input type="checkbox"/> A5086 <input type="checkbox"/> AG5086	selector switch - rotary changeover switch 1P 3 A - 250 Va.c. - 1 way - 4 positions to control air conditioners, fans, etc.

ITEM	TWO-WAY SWITCHES
<input type="checkbox"/> AM5003E <input type="checkbox"/> A5003E <input type="checkbox"/> AG5003E	1P 16 AX - 250 Va.c.
<input type="checkbox"/> AM5003/2E <input type="checkbox"/> A5003/2E <input type="checkbox"/> AG5003/2E	1P 16 AX - 250 Va.c. - Optional add on lightable with led lamp LN4742V230 - LN4742V230V - device with backlight clearly visible even in daylight and in well-it
<input type="checkbox"/> AM5003/2E <input type="checkbox"/> A5003/2E <input type="checkbox"/> AG5003/2E	1P 16 AX - 250Va.c. - 2 modules
ITEM	PUSHBUTTONS
<input type="checkbox"/> AM5005E <input type="checkbox"/> A5005E <input type="checkbox"/> AG5005E	1P (NO) 10 A - 250 Va.c.
<input type="checkbox"/> AM5005LE <input type="checkbox"/> A5005LE <input type="checkbox"/> AG5005E	1P (NO) 10 A - 250 Va.c. - Optional add on lightable with led lamp LN4742V230 - LN4742V230V - device with backlight clearly visible even in daylight and in well-it
<input type="checkbox"/> AM5005LBE <input type="checkbox"/> A5005LBE <input type="checkbox"/> AG5005LBE	1P (NO) 10 A - 250 Va.c. "bell symbol" - Optional add on lightable Lamp to be added LN4742V230 - LN4742V230V
<input type="checkbox"/> AM5005LLE <input type="checkbox"/> A5005LLE <input type="checkbox"/> AG5005LLE	1P (NO) 10 A - 250 Va.c. "lamp symbol" - Optional add on lightable Lamp to be added LN4742V230 - LN4742V230V
<input type="checkbox"/> AM5037 <input type="checkbox"/> A5037 <input type="checkbox"/> AG5037	double 1P (NO) + 1P (NO) 10A - 250Va.c. interlocked

SOCKETS
مخارج كهرباء



ITEM	ITALIAN STANDARD SOCKETS
<input type="checkbox"/> AM5180E <input type="checkbox"/> A5180E <input type="checkbox"/> AG5180E <input type="checkbox"/> A5180RE	socket 2P+E 10A and 16 A 250 Va.c. - centre distance 19 mm and 26 mm shielded holes
<input type="checkbox"/> AM5113E <input type="checkbox"/> A5113E <input type="checkbox"/> AG5113E	socket 2P+E 10 A 250 Va.c. - centre distance 19 mm shielded holes Ø 4 mm
ITEM	EURO-AMERICAN STANDARD SOCKETS
<input type="checkbox"/> AM5025RE <input type="checkbox"/> A5025RE <input type="checkbox"/> AG5025RE	socket 2P 16 A 127/250 Va.c. - shielded holes
<input type="checkbox"/> AM5025SE <input type="checkbox"/> A5025SE <input type="checkbox"/> AG5025SE	socket 2P 16 A 127/250 Va.c. - unshielded holes

ITEM	MULTISTANDRD SOCKET
<input type="checkbox"/> AM5039 <input type="checkbox"/> A5039 <input type="checkbox"/> AG5039	socket 2P+E 5/6/10/13 A 250 Va.c. and 127 Va.c. multistandard - 5 A and 13 A = BS std., 6 A = Indian std., 10 A = European std.
ITEM	GERMAN STANDARD SOCKETS
<input type="checkbox"/> AM5440/3E <input type="checkbox"/> A5440/3E <input type="checkbox"/> AG5440/3E <input type="checkbox"/> A5440/30E <input type="checkbox"/> A5440/3RE	socket 2P+E 10/16A 250V - type earth side contacts - shielded socket contacts

TV, TELEPHONE, DATA SOCKETS
مخارج تليفزيون، تليفون و انترنت



ITEM	TV JACKS
<input type="checkbox"/> AM5202D <input type="checkbox"/> A5202D <input type="checkbox"/> AG5202D	Star coaxial socket for single-user aerial systems, also remote powered and centralised, and singleuser / centralised satellite systems with current and signal transfer for channels selection; shielded connection clamps with captive screws - Ø 9.5 mm; male connector - 1 module
<input type="checkbox"/> AM5173DFE <input type="checkbox"/> A5173DFE <input type="checkbox"/> AG5173DFE	type F TV coax connector - impedance 75Ω - screw coupling
<input type="checkbox"/> AM5210M2D <input type="checkbox"/> A5210M2D <input type="checkbox"/> AG5210M2D	Star demixed coaxial socket for single-user aerial systems, also remote powered and shunting centralised, and for single-user/shunting centralised satellite systems with current and signal transfer for channels selection, and for radio systems; 0.9.5 mm male TV connector - type F SAT connector and female radio Ø 9.5 mm - 2 modules

ITEM	RJ11 CONNECTORS	type of connector	No. of pairs	No. of connection
<input type="checkbox"/> AM5958/11NE <input type="checkbox"/> A5958/11NE <input type="checkbox"/> AG5958/11NE		RJ11	2	K10
ITEM	RJ11 CONNECTORS	type of connector	cat.	No. of connection
<input type="checkbox"/> AM5979C5E <input type="checkbox"/> A5979C5E <input type="checkbox"/> AGE5979C5E		RJ45	5E UTP	Cutter(1)
<input type="checkbox"/> AM5979C6 <input type="checkbox"/> A5979C6 <input type="checkbox"/> AGE5979C6		RJ45	6 UTP	Cutter(1)

(1) TOOLLESS type

AUDIO VIDEO CONNECTORS
مخارج الصوت والصورة



ITEM	AUDIO VIDEO CONNECTORS
<input type="checkbox"/> AM4281 <input type="checkbox"/> AM4281 <input type="checkbox"/> AG4281	connector - RCA x 2
<input type="checkbox"/> AM4282 <input type="checkbox"/> A4282 <input type="checkbox"/> AG4282	connector - HD15
<input type="checkbox"/> AM4283 <input type="checkbox"/> A4283 <input type="checkbox"/> AG4283	RCA x 3 connector
<input type="checkbox"/> AM4284 <input type="checkbox"/> A4284 <input type="checkbox"/> AG4284	HDMI connector
<input type="checkbox"/> AM4285 <input type="checkbox"/> A4285 <input type="checkbox"/> AG4285	USB connector
ITEM	AUDIO POTENTIOMETER
<input type="checkbox"/> AM5305 <input type="checkbox"/> A5305 <input type="checkbox"/> AG5305	audio potentiometer 0-5W 47 Ohm

(*) ITEMS MANAGED ON DEMAND. TO ORDER CONSULT THE BTICINO SALES STAFF

EMERGENCY LAMPS
مصابيح الطوارئ

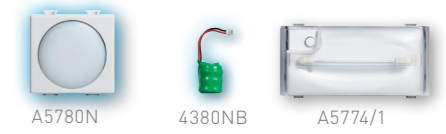

ITEM	REMOVABLE LED LAMP
<input type="checkbox"/> A5780N	It automatically turns on in case of power failure. Push&Pull extracting system - high efficiency white LED - ON/OFF switch and SPOT button to increase light intensity if needed - interchangeable Ni-MH batteries with 2h duration - low consumption in stand-by 0,4W - 127/230V power supply. Recharging base, 2 modules.
<input type="checkbox"/> 4380NB	spare battery for rechargeable torch art. A5780N
<input type="checkbox"/> A5774/1	emergenCY LAMPS

DIMMERS
ديمرات



ITEM	DIMMER
<input type="checkbox"/> AM5702 <input type="checkbox"/> A5702 <input type="checkbox"/> AG5702	rotary dimmer - built-in two way switch - MOSFET tech. - built-in fuse 60-500 W 230 Va.c.
<input type="checkbox"/> AM5706 <input type="checkbox"/> A5706 <input type="checkbox"/> AG5706	rotary dimmer 100 - 500 W 230 Va.c.

NOTE: to choose the dimmer according to the technical features, see the table below

ITEM	UNIVERSAL DIMMER
<input type="checkbox"/> AM5713 <input type="checkbox"/> A5713 <input type="checkbox"/> AG5713	universal dimmer (resistive - inductive, capacitive, fluorescent compact and dimmer LEDs) - 150/200/400 W with electronic protection - 2 modules

NOTE: to choose the dimmer according to the technical features, see the table below

Loads managed

Item	Type	Range	supply std	Incandescents and halogens	Halogens with ferromagnetic transformer	Halogens with electronic transformer	Dimmerable compact fluorescents	Dimmerable lead lamps	F luorescents with electronic 0-10 V ballast
AM5702 A5702 AG5702	Resistive	230 50	230 Va.c.	60 ÷ 500 W					
AM5706 A5706 AG5706	Resistive	230 50 ÷ 60	230 Va.c.	100 ÷ 500 W					
AM5713 A5713 AG5713	Universal	100 ÷ 240 50 ÷ 60	240 Va.c. 100 Va.c.	3 ÷ 200 W 3 ÷ 400 W	3 ÷ 200 VA 3 ÷ 400 VA	3 ÷ 200 VA 3 ÷ 400 VA	3 ÷ 75 W 3 ÷ 150 W	3 ÷ 75 W 3 ÷ 150 W	

SPECIAL SOCKETS
مخارج للإستخدامات الخاصة



ITEM	USB CHARGER
<input type="checkbox"/> AM5285C1 <input checked="" type="checkbox"/> A5285C1 <input checked="" type="checkbox"/> AG5285C1	USB connector 5 Vdc USB charger to be used only for recharging electronic devices up to 1100 mA like mobile phones, smartphones, tablets and similar - 230 Va.c. power supply
<input type="checkbox"/> AM5285C2 <input checked="" type="checkbox"/> A5285C2 <input checked="" type="checkbox"/> AG5285C2	USB connector 5 Vdc USB charger for quick charge of one single electronic device (mobile phones, smartphones, tablets or similar) up to 2400 mA or simultaneous charging of two devices up to 1200 mA - 110=230 Vac 50=60 Hz power supply

ITEM	PASSIVE INFRARED SWITCHES
<input type="checkbox"/> AM5751 <input checked="" type="checkbox"/> A5751 <input checked="" type="checkbox"/> AG5751	switch with passive infrared ray movement sensor - variable threshold twilight circuit with possibility of exclusion - timing circuit to delay switching off which can be adjusted from 30 seconds to 10 minutes - out put relay 2 A resistive/ inductive - 230 Va.c. power supply - 50 and 60 Hz

ITEM	BLANKING MODULES AND OUTPUTS
<input type="checkbox"/> AM5000E <input checked="" type="checkbox"/> A5000E <input checked="" type="checkbox"/> AG5000E	blanking module key

LED
لمبات



ITEM	LEDS FOR CONTROLS AND LIGHTS
<input type="checkbox"/> LN4742V230	LED for rocker controls 230 V - amber
<input type="checkbox"/> LN4742V230V	LED for rocker controls 230 V - green

NOTE: 127V and 12/24V are also available.

AUDIBLE & OPTICAL SIGNALLING
الأجراس ولمبات البيان



ITEM	STEP MARKER LAMP
<input type="checkbox"/> AM5041 <input checked="" type="checkbox"/> A5041N <input checked="" type="checkbox"/> AG5041	bronze bell 230 Va.c. - 11 VA - 80 dB
<input type="checkbox"/> AM5048 <input checked="" type="checkbox"/> A5048N <input checked="" type="checkbox"/> AG5048N	buzzer 230 Va.c. - 10VA - 75 dB

ITEM	BUZZERS AND BELLS
<input type="checkbox"/> A5630/230	bronze bell 230 Va.c. - 11 VA - 80 dB
<input type="checkbox"/> A5631/230	buzzer 230 Va.c. - 10VA - 75 dB

ITEM	LAMP-HOLDER
<input type="checkbox"/> AM5062B <input checked="" type="checkbox"/> A5062B <input checked="" type="checkbox"/> AG5062B	double lamp-holder with 2 diffusers: 1 orange + 1 clear - for lamps item LN4742V230 - LN4742V230V
<input type="checkbox"/> AM5064V <input checked="" type="checkbox"/> A5064V <input checked="" type="checkbox"/> AG5064V	double lamp-holder with 2 diffusers: 1 red + 1 green - for lamps item LN4742V230 - LN4742V230V

<input type="checkbox"/> AM5060A <input checked="" type="checkbox"/> A5060A <input checked="" type="checkbox"/> AG5060A	lamp-holder with orange diffuser - for lamps item LN4742V230 - LN4742V230V
<input type="checkbox"/> AM5060R <input checked="" type="checkbox"/> A5060R <input checked="" type="checkbox"/> AG5060R	lamp-holder with red diffuser - for lamps item LN4742V230 - LN4742V230V

<input type="checkbox"/> AM5060B <input checked="" type="checkbox"/> A5060B <input checked="" type="checkbox"/> AG5060B	lamp-holder with clear diffuser - for lamps item LN4742V230 - LN4742V230V
<input type="checkbox"/> AM5060V <input checked="" type="checkbox"/> A5060V <input checked="" type="checkbox"/> AG5060V	lamp-holder with green diffuser - for lamps item LN4742V230 - LN4742V230V

MATIX EDGE - SUPPORT FRAMES

SUPPORT FRAMES

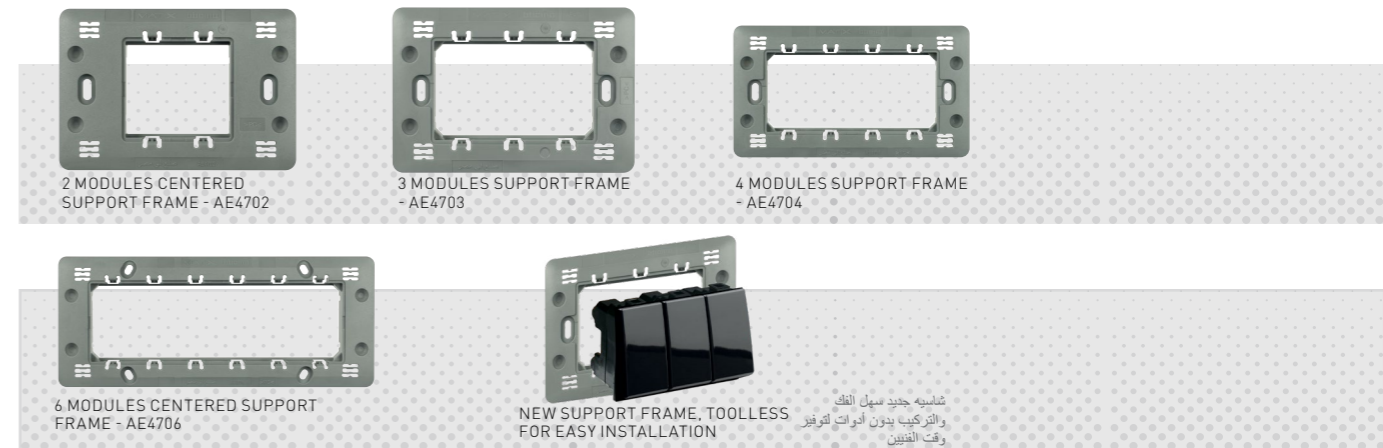

MATIX EDGE - 3 MODULE INSTALLATION SYSTEM
COVER PLATE INSTALLATION

BOXES	SUPPORTS	NO. OF MODULES	MATIX EDGE COVER PLATES
503EG (106X71X52 MM)	AE4703 WITH SCREWS	3 MODULES	AE4803M3...

IDROBOX - IP55 WATERPROOF
غطاء حماية ضد الماء



ITEM	IDROBOX - IP55 WATERPROOF COVER
<input type="checkbox"/> 25602B <input checked="" type="checkbox"/> 25602	2 module MATIX IDROBOX - Installation on 502E flush mounting box 2 modules grey RAL7035
<input type="checkbox"/> 25603B <input checked="" type="checkbox"/> 25603	3 module MATIX IDROBOX - Installation on 503E flush-mounting box 3 modules grey RAL7035
<input type="checkbox"/> 25604B <input checked="" type="checkbox"/> 25604	4 module MATIX IDROBOX - Installation on 504E flush-mounting box 4 modules grey RAL7035

COVER PLATES:
TABLE FOR SELECTING CODE
إختيار أوجه الماتكس إيدج

MODULES						
	1	2 CENTRED	3	4	6	
NATURALS						
	WHITE	AE4803M1BN	AE4803M2BN	AE4803M3BN	AE4804BN	AE4806BN
	IVORY	AE4803M1AV	AE4803M2AV	AE4803M3AV	AE4804AV	AE4806AV
	GREY			AE4803M3GR	AE4804GR	AE4806GR
COLORS						
	BEIGE			AE4803M3BG	AE4804BG	AE4806BG
	BLACK			AE4803M3BK	AE4804BK	AE4806BK
	BROWN			AE4803M3BR	AE4804BR	AE4806BR
	PINK			AE4803M3PN	AE4804PN	AE4806PN
	LIGHT PURPLE			AE4803M3LP	AE4804LP	AE4806LP
	PURPLE			AE4803M3PR	AE4804PR	AE4806PR
	LEMON			AE4803M3LM	AE4804LM	AE4806LM
	AMBER			AE4803M3AM	AE4804AM	AE4806AM
	RED			AE4803M3RD	AE4804RD	AE4806RD
	TURQUOISE			AE4803M3TR	AE4804TR	AE4806TR
	BLUE			AE4803M3BL	AE4804BL	AE4806BL
	DARK BLUE			AE4803M3DB	AE4804DB	AE4806DB
	GREEN TEA			AE4803M3GT	AE4804GT	AE4806GT
	GREEN			AE4803M3GN	AE4804GN	AE4806GN
METALS						
	MATT GOLD			AE4803M3MGL	AE4804MGL	AE4806MGL
	SILVER			AE4803M3MSL	AE4804MSL	AE4806MSL
	IRON			AE4803M3MIR	AE4804MIR	AE4806MIR
	STAINLESS			AE4803M3MST	AE4804MST	AE4806MST
	PEARL			AE4803M3MPL	AE4804MPL	AE4806MPL
	TITANIUM			AE4803M3MTA	AE4804MTA	AE4806MTA
	COPPER			AE4803M3MCO	AE4804MCO	AE4806MCO
	BRONZE			AE4803M3MBZ	AE4804MBZ	AE4806MBZ
SUPPORTS						
FIXING WITH SCREWS	AE4703	AE4702	AE4703	AE4704	AE4706	

MATIX EDGE - 3 MODULE COVER PLATE COLOURS

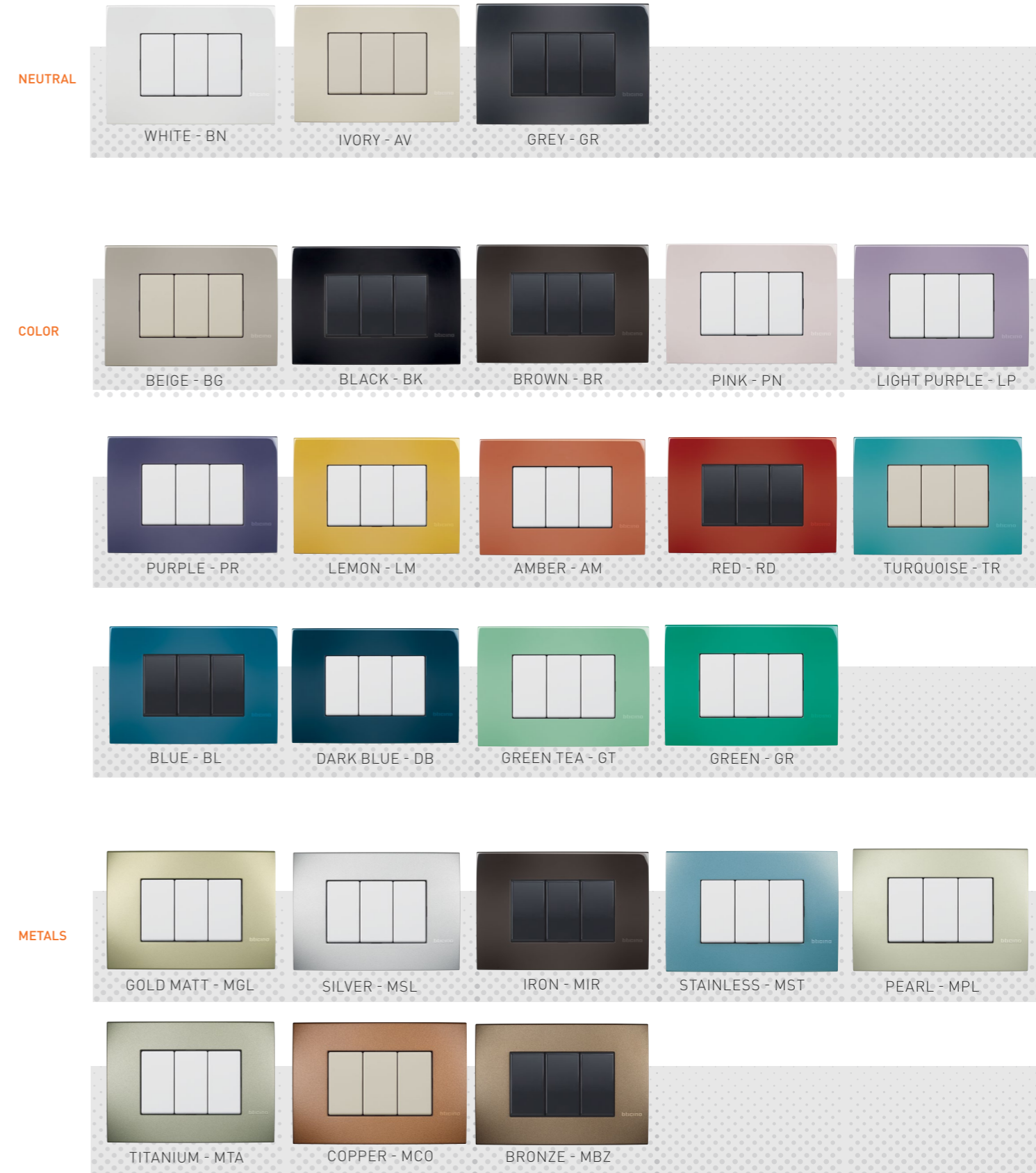



SOLIDA

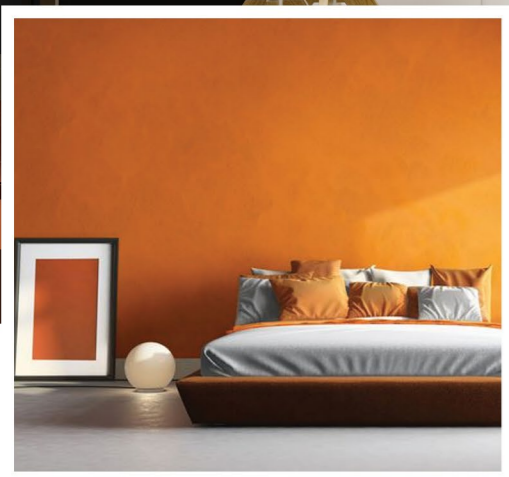

COMBINATION
OF QUALITY & VALUE



SOLIDA

IDEAL FOR RESIDENTIAL & SMALL BUSINESS APPLICATIONS

HOUSES, FLATS, SMALL OFFICES, SMALL SHOPS



THE RANGE WIDENS WITH NEW FINISHES

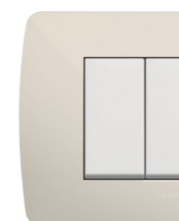

New finishings: **neutrals**
Example **IVORY**
White, Ivory

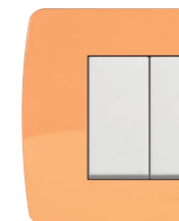

New finishings: **colors**
Example **LIGHT AMBER**
Blue, Black, Pine, Pink, Light amber,
Light yellow, Bright red



New finishings: **metal effect**
Example **TITANIUM**
Titanium, Light brown, Red,
Dark brown, Blue violet, Silver, Matt gold

AESTHETIC FEATURES:

mechanism with white or ivory gloss finish, and illuminated switches. Cover plates with smooth shapes.

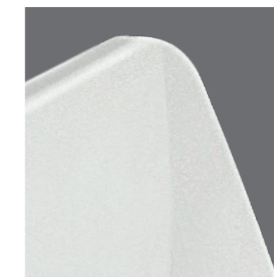

EASY TO INSTALL AND WIRE

آمن و سهل التوصيل

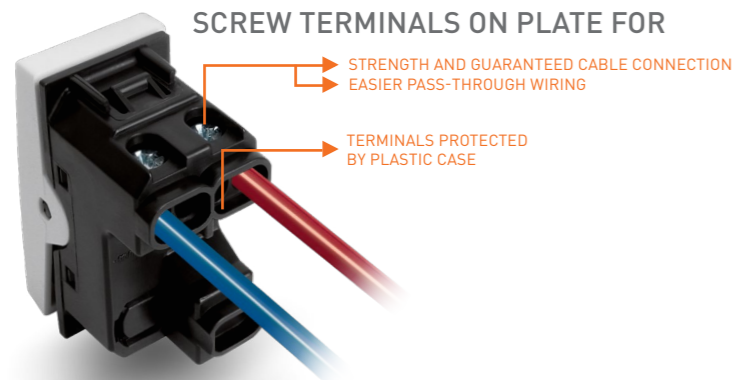

CHILDPROOF

آمن للأطفال

German and Italian standard socket outlets, all with safety shutters designed to protect children



CONTROL DEVICES

مفاتيح التحكم الأساسية

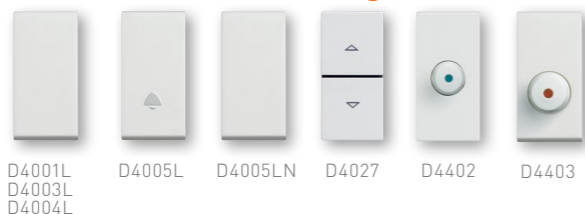

ITEM	CONTROL DEVICES
<input type="checkbox"/> D4001L <input checked="" type="checkbox"/> DA4001L	One-way switch 1P 16 AX 250 Va.c.
<input type="checkbox"/> D4003L <input checked="" type="checkbox"/> DA4003L	Two-way switch 1P 16 AX 250 Va.c.
<input type="checkbox"/> D4005L <input checked="" type="checkbox"/> DA005L	Pushbutton 1P (NO) 10 A 250 Va.c. with bell symbol
<input type="checkbox"/> D4005LN <input checked="" type="checkbox"/> DA4005LN	Pushbutton 1P (NO) 10 A 250 Va.c.

ITEM	CONTROL DEVICES
<input type="checkbox"/> D4004L <input checked="" type="checkbox"/> DA4004L	Four-way switch 16A 250Va.c.
<input type="checkbox"/> D4027 <input checked="" type="checkbox"/> DA4027	1 P 1-0-2 double-key changeover switch 16 A 250 Va.c.
<input type="checkbox"/> D4402 <input checked="" type="checkbox"/> DA4402	Rotary dimmer - built-in two way switch -MOS-FET tech. - built-in fuse 60-500 W 230 Va.c.
<input type="checkbox"/> D4403 <input checked="" type="checkbox"/> DA4403	Resistive dimmer for incandescent and halogen lamps. 100-500W 230 Va.c.

SOCKETS

مخارج كهرباء



ITEM	SOCKET OUTLETS
<input type="checkbox"/> D4125 <input checked="" type="checkbox"/> DA4125	Euro-american standard socket 2P 16 A 127/250 Va.c. - Ø 5 mm
<input type="checkbox"/> D4140 <input checked="" type="checkbox"/> DA4140	German standard socket 2P+E 16 A 127/250 Va.c. P31 type - with shutters for child protection
<input type="checkbox"/> D4180 <input checked="" type="checkbox"/> DA4180	Italian standard socket 2P+E 16 A 250 Va.c. - centre distance 19 mm and 26 mm - for plugs 2P and 2P+E 10 and 16 A - with shutters for child protection

ITEM	SOCKET OUTLETS
<input type="checkbox"/> D4122ET <input checked="" type="checkbox"/> DA4122ET	Egyptian standard socket 2P 10 A 250 Va.c.- contact tubes Ø 4 - 4.8 mm - centre line of holes 19 mm
<input type="checkbox"/> D5285C1 <input checked="" type="checkbox"/> DA5285C1	5 Vd.c. USB charger to be used only for recharging electronic devices up to 1100 mA like mobile phones, smartphones, tablets and similar - 230 Va.c. power supply

ACCESSORIES

الإكسسوارات



ITEM	ACCESSORIES
<input type="checkbox"/> D4950S <input checked="" type="checkbox"/> DA4950S	1-module blanking plate
<input type="radio"/> LN4742V230	LED for control devices 230 V - amber

BELLS

الأجراس



ITEM	BELLS
<input type="checkbox"/> D4351/230 <input checked="" type="checkbox"/> DA4351/230	Bronze Bell - 230Vac - 11 VA - 80 dB

TV, RJ11, RJ45 SOCKETS

مخارج تليفزيون، تليفون وإنترنت



CAT. NO.	TV, RJ11, RJ45 SOCKET
<input type="checkbox"/> D4202D <input checked="" type="checkbox"/> DA4202D	Shunted coaxial jack - Ø 9,5 mm - male jack - screened TV + SAT sockets in die cast housing with current flow
<input type="checkbox"/> D4269F <input checked="" type="checkbox"/> DA4269F	Type F TV female connector - 75 Ω impedance - screw coupling - 1 module
<input type="checkbox"/> D4232RJ11 <input checked="" type="checkbox"/> DA4232RJ11	RJ 11 telephone sockets





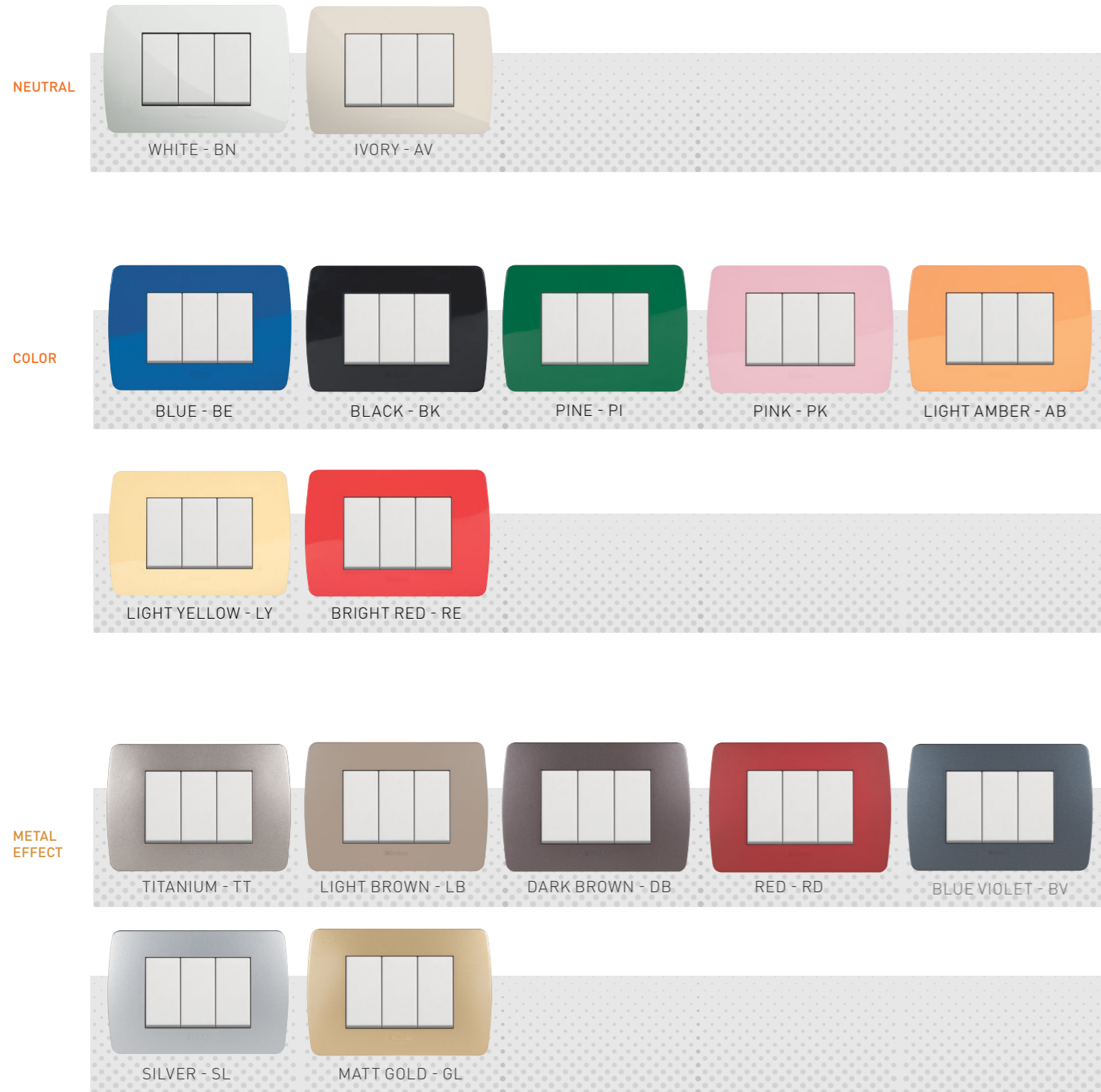





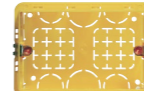
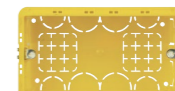



<input type="checkbox"/> D4262C5E <input checked="" type="checkbox"/> DA4262C5E	RJ 45 data transmission/ telephone sockets - 110IDC cat5E UTP
<input type="checkbox"/> D5979C6 <input checked="" type="checkbox"/> DA5979C6	RJ45 Cat. 6 - UTP - Type of connection: TOOLLESS

COVER PLATES: COLOURS RANGE

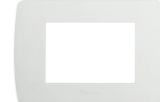

EASY AND SECURE INSTALLATION
آمن و سهل التركيب

TABLE OF CHOICE

BOXES	 503EG	 504E	 506L		
FRAMES	 D4703	 D4704	 D4706		
N° OF MODULES	 1 MODULE	 2 MODULES	 3 MODULES	 4 MODULES	 6 MODULES
PLATES	 D4803M1...	 D4803M2...	 D4803M3...	 D4804...	 D4806...

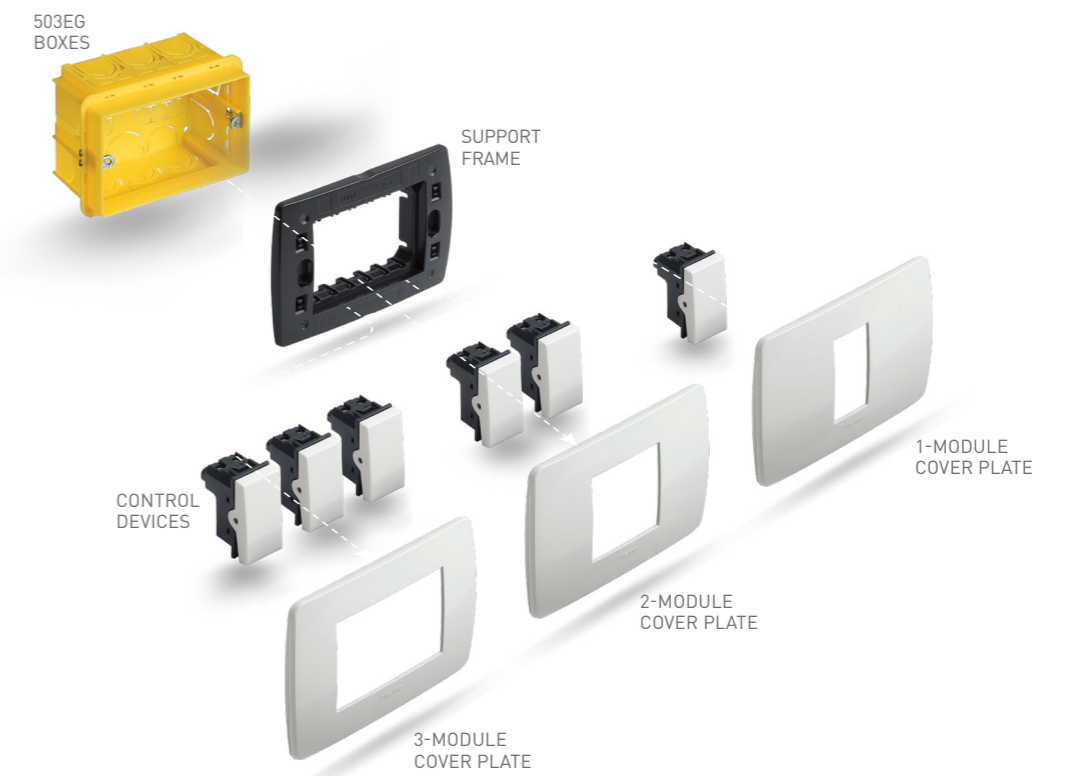

TABLE FOR SELECTING CODE

إختيار أوجه السوليدا

MODULES	1	2	3	4	6
	■	■ ■	■ ■ ■	■ ■ ■ ■	■ ■ ■ ■ ■ ■

NATURALS						
■	WHITE	D4803M1BN	D4803M2BN	D4803M3BN	D4804BN	D4806BN
■	IVORY	D4803M1AV	D4803M2AV	D4803M3AV	D4804AV	D4806AV

COLORS						
■	BLUE	D4803M1BE	D4803M2BE	D4803M3BE	D4804BE	D4806BE
■	BLACK	D4803M1BK	D4803M2BK	D4803M3BK	D4804BK	D4806BK
■	PINE	D4803M1PI	D4803M2PI	D4803M3PI	D4804PI	D4806PI
■	PINK	D4803M1PK	D4803M2PK	D4803M3PK	D4804PK	D4806PK
■	LIGHT AMBER	D4803M1AB	D4803M2AB	D4803M3AB	D4804AB	D4806AB
■	LIGHT YELLOW	D4803M1LY	D4803M2LY	D4803M3LY	D4804LY	D4806LY
■	BRIGHT RED	D4803M1RE	D4803M2RE	D4803M3RE	D4804RE	D4806RE

METALS EFFECT						
■	TITANIUM	D4803M1TT	D4803M2TT	D4803M3TT	D4804TT	D4806TT
■	LIGHT BROWN	D4803M1LB	D4803M2LB	D4803M3LB	D4804LB	D4806LB
■	RED	D4803M1RD	D4803M2RD	D4803M3RD	D4804RD	D4806RD
■	DARK BROWN	D4803M1DB	D4803M2DB	D4803M3DB	D4804DB	D4806DB
■	BLUE VIOLET	D4803M1BV	D4803M2BV	D4803M3BV	D4804BV	D4806BV
■	SILVER	D4803M1SL	D4803M2SL	D4803M3SL	D4804SL	D4806SL
■	MATT GOLD	D4803M1GL	D4803M2GL	D4803M3GL	D4804GL	D4806GL

FRAME
الشاسيه

D4703	D4703	D4703	D4704	D4706
-------	-------	-------	-------	-------

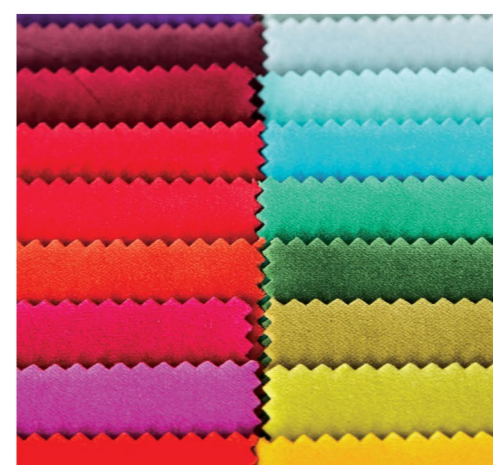

FORMA MAX

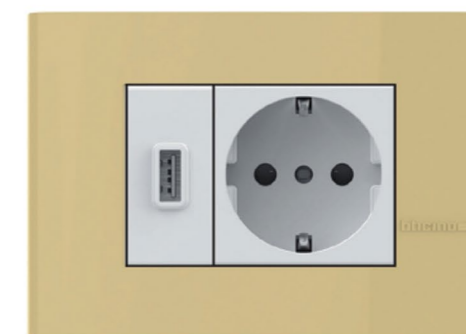
JUST WHAT
YOU NEED

FORMA MAX

NEW DESIGN

The Italian style, quality and originality guarantee by BTicino



The new plate is characterized by a very taut surface that connects on the sides with a nice curve; the curve is also highlighted by the brand completed by a satin line that links the plates to the wall. The plate is also decorated with a subtle effect obtained thanks to the up and down edges.



Slim effect

Squared shape with sophisticate curves on sides

Branded Detail

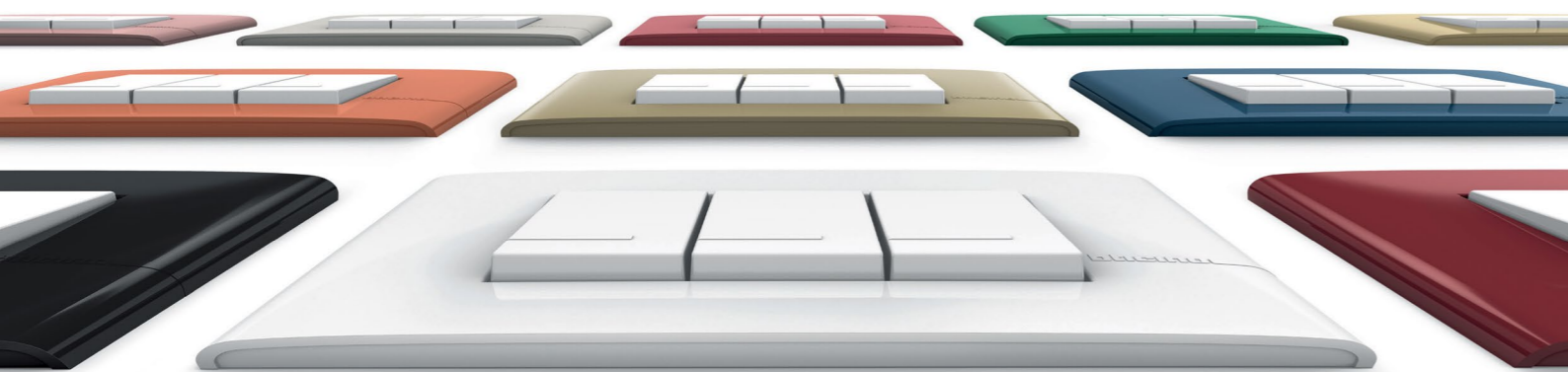

FORMA MAX



NEW AND ESSENTIAL FINISHES

TOTAL LOOK

White and ivory that you combine with the keys give total look effect

COLORS

Blue, Black, Pine, Pink, Light amber, Light yellow, Bright red

METALS

Titanium, Light brown, Red, Dark brown, Blue violet, Silver, Matt gold

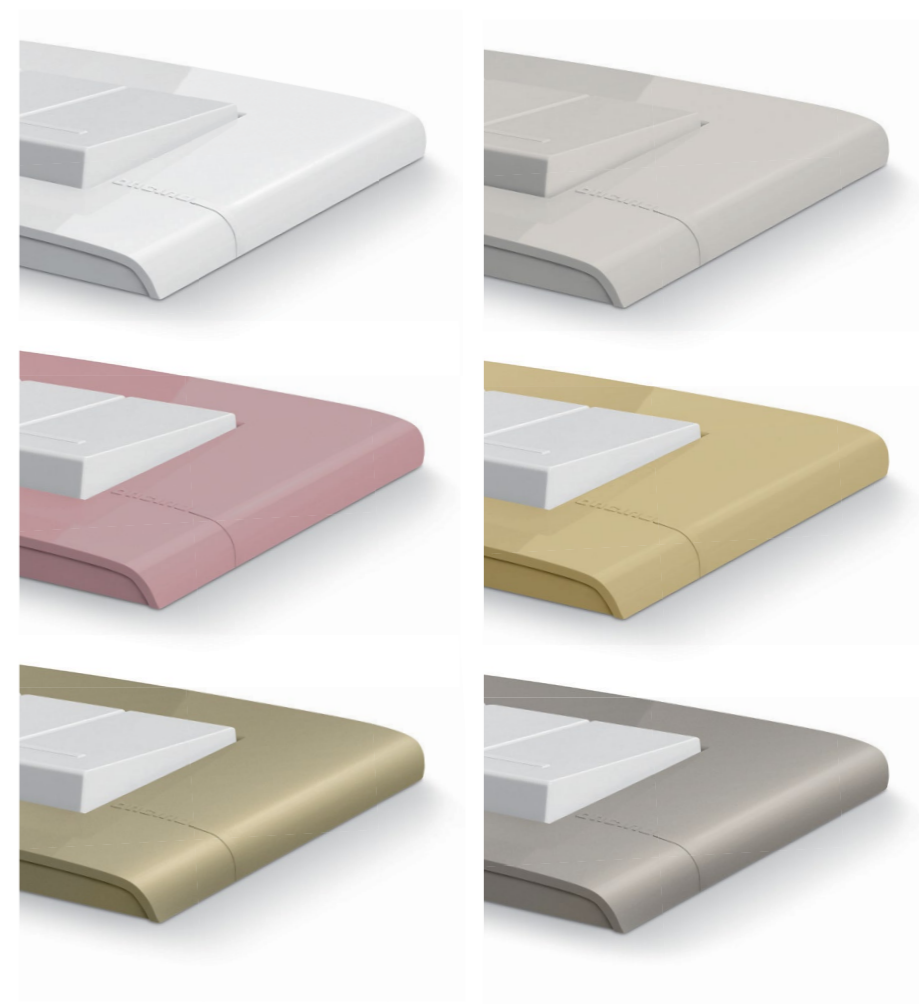

EASY AND SECURE INSTALLATION

INSTALLATION FROM THE FRONT

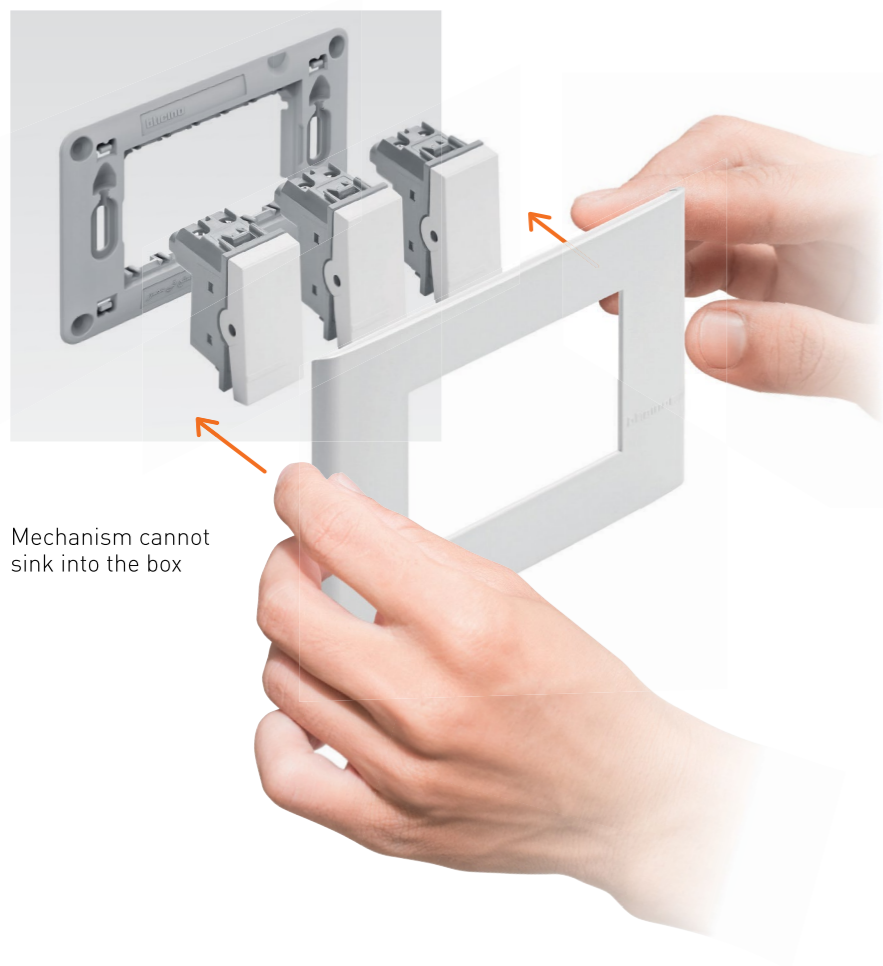

Mechanism cannot sink into the box

EASY TO INSTALL AND WIRE

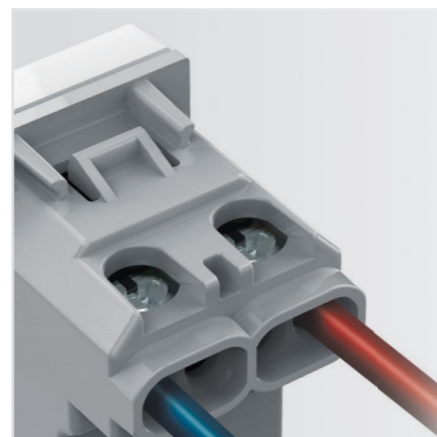

SCREW TERMINALS ON PLATE FOR

- Strength and guaranteed cable connection
- Easier pass-through wiring
- Terminals protected by plastic case



PLATE
The plate screw terminals ensure durable connections

NEW OFFER USB CHARGER



The USB chargers, suitable for smartphones, Mp3 players, navigators, tablets etc., guarantee a fast charge and greater power, adapting perfectly to the energy requirements of latest generation batteries.

SUITABLE for all rooms thanks to their small size. Recommended in the bedroom or kitchen.

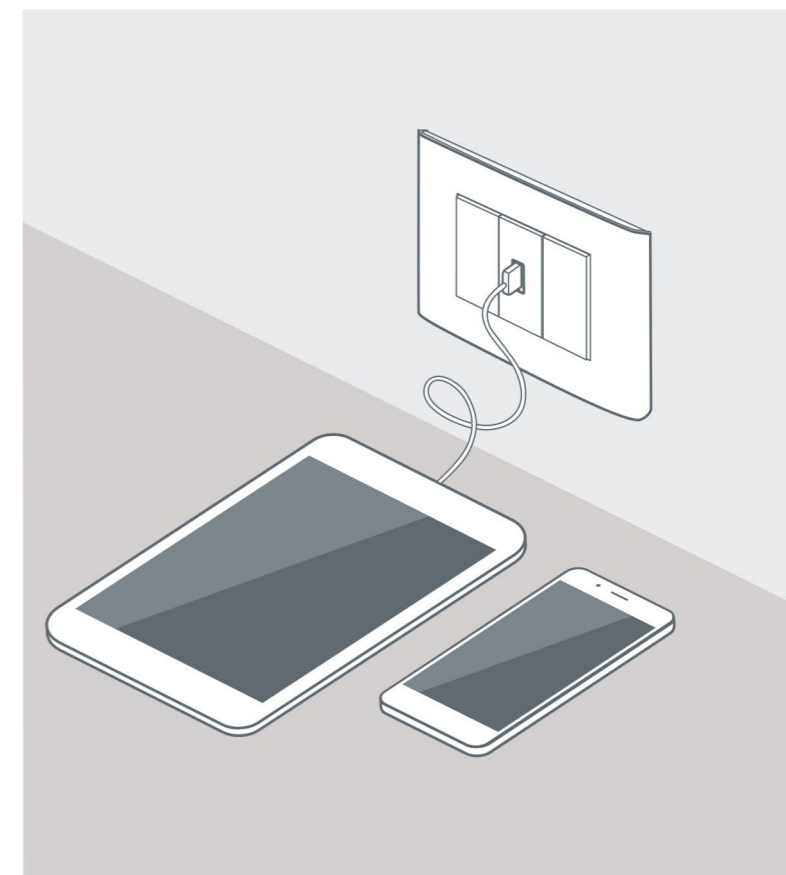

The Forma Max range widens with more new functions



BE4004LW



Resistive dimmer
BE4403W



BE4232RJ11W

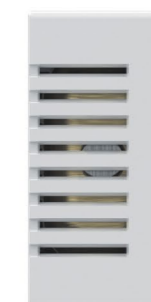

BE4351V230W

CONTROL DEVICES

مفاتيح التحكم الرئيسية



BE4001LW BE4003LW BE4004LW BE4403W BE4005LW

SOCKET OUTLETS

مخارج كهرباء



BE4122ETW BE4140W BE4180W BE5285C1W

ITEM	CONTROL DEVICES
<input type="checkbox"/> BE4001LW <input checked="" type="checkbox"/> BE4001LY	One-way switch 1P 10 AX 250 Va.c. - White/Ivory
<input type="checkbox"/> BE4003LW <input checked="" type="checkbox"/> BE4003LY	Two-way switch 1P 10 AX 250 Va.c. - White/Ivory
<input type="checkbox"/> BE4004LW <input checked="" type="checkbox"/> BE4004LY	Four-way switch 1P 10 AX 250 Va.c. - White/Ivory
<input type="checkbox"/> BE4403W <input checked="" type="checkbox"/> BE4403Y	Resistive dimmer for incandescent and halogen lamps. 100-500W 230 Va.c. - White/Ivory
<input type="checkbox"/> BE4005LW <input checked="" type="checkbox"/> BE4005LY	Pushbutton 1P (NO) 16A 250 Va.c. - White/Ivory

ITEM	SOCKET OUTLETS
<input type="checkbox"/> BE4122ETW <input checked="" type="checkbox"/> BE4122ETY	Egyptian standard socket 2P 10 A 250 Va.c. - contact tubes Ø 4 - 4.8 mm - centre line of holes 19 mm. White/Ivory
<input type="checkbox"/> BE4125W <input checked="" type="checkbox"/> BE4125Y	Euro american standard socket 2P 16 A 250 /127 Va.C.Ø 5mm
<input type="checkbox"/> BE4140W <input checked="" type="checkbox"/> BE4140Y	German standard socket 2P+E 16 A - 127/250 Va.c. P31 type - with shutters for child protection. White/Ivory
<input type="checkbox"/> BE4180W <input checked="" type="checkbox"/> BE4180Y	Italian standard socket 2P+E 16 A 250 Va.c.- centre distance 19 mm and 26 mm - for plugs 2P and 2P+E 10 and 16 A - with shutters for child protection. White/Ivory
<input type="checkbox"/> BE5285C1W <input checked="" type="checkbox"/> BE5285C1Y	5 Vd.c. USB charger to be used only for recharging electronic devices up to 1500 mA like mobile phones, smartphones, tablets and similar - 230 Va.c. power supply. White/Ivory

TV, RJ11, RJ45 SOCKET

مخارج تلفزيون, تليفون و إنترنت



BE4269FW BE4232RJ11W BE4262C5EW BE5979C6W

BELLS

الأجراس



BE4351V230W

ACCESSORIES

الإكسسورات



BE4950SW

ITEM	TV, RJ11, RJ45 SOCKET
<input type="checkbox"/> BE4269FW <input checked="" type="checkbox"/> BE4269FY	Type F TV female connector 75 Ω impedance Screw coupling 1 module White/Ivory
<input type="checkbox"/> BE4232RJ11W <input checked="" type="checkbox"/> BE4232RJ11Y	RJ 11 telephone sockets 1 module White/Ivory
<input type="checkbox"/> BE4262C5EW <input checked="" type="checkbox"/> BE4262C5EY	RJ 45 data transmission/ telephone sockets - 110IDC cat5E UTP - 1 module White/Ivory
<input type="checkbox"/> BE5979C6W <input checked="" type="checkbox"/> BE5979C6Y	RJ 45 data transmission/ telephone sockets - 110IDC cat6 UTP - 1 module White/Ivory





ITEM	BELLS
<input type="checkbox"/> BE4351V230W <input checked="" type="checkbox"/> BE4351V230Y	Bronze Bell - 230Vac - 12 VA - 80 dB. White/Ivory

ITEM	ACCESSORIES
<input type="checkbox"/> BE4950SW <input checked="" type="checkbox"/> BE4950SY	1-module blanking plate White/Ivory

NOTE

W = references White color
Y = references Ivory color

TABLE OF CHOICE

Boxes	 503EG	Plasterboard boxes	 PB503N	Frames	 BE4703
N° of modules	 3 modules	Plates	 D4803M3...		

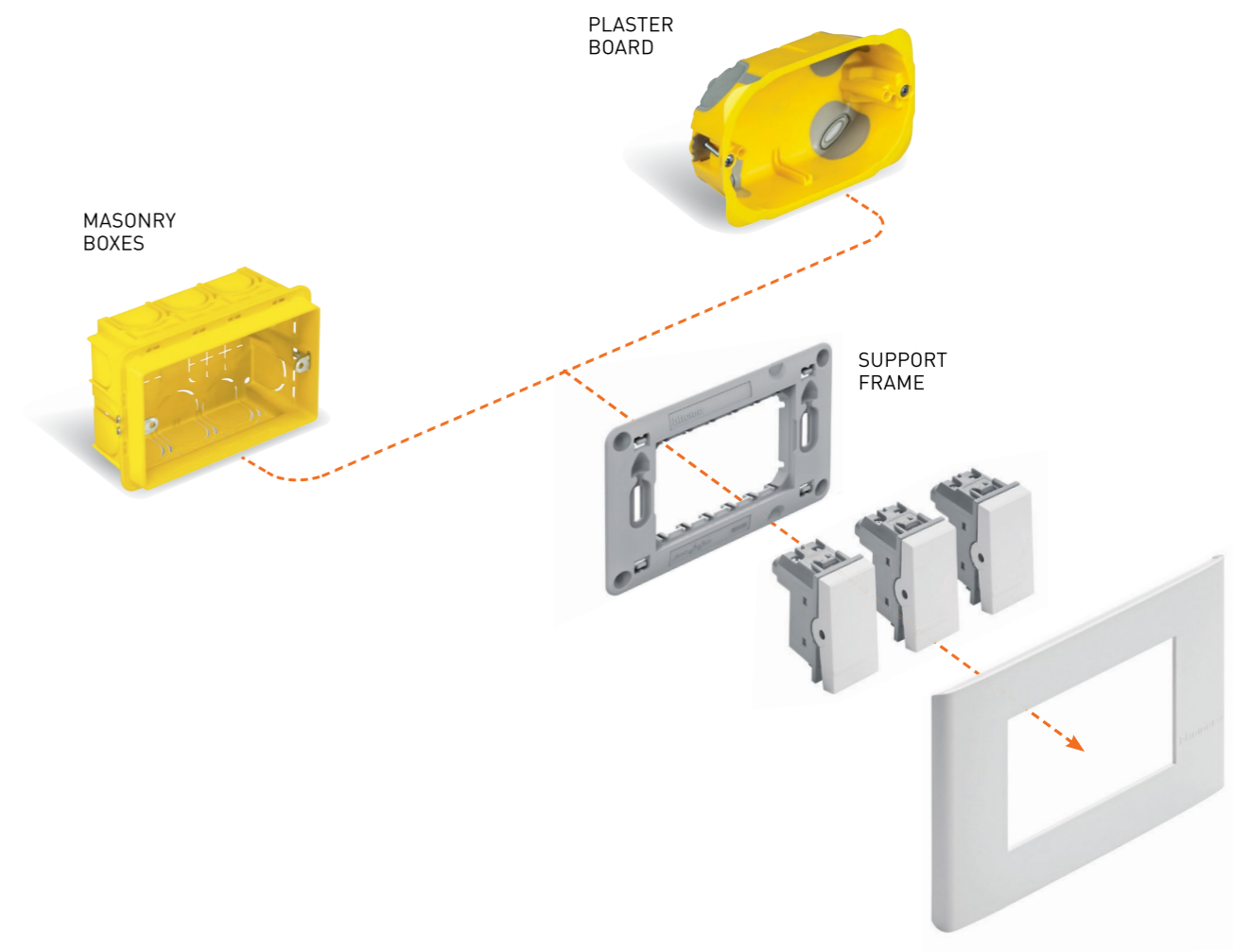

TOTAL LOOK

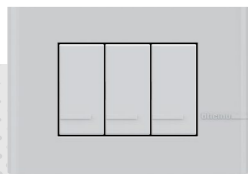

WHITE - BE4803M3BN

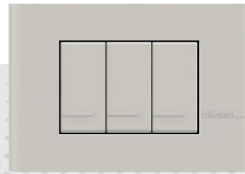

IVORY - BE4803M3AV

COLOR

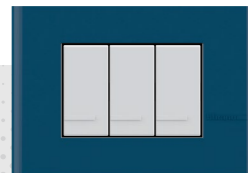

BLUE BE - BE4803M3BE



BLACK BK - BE4803M3BK

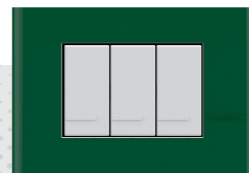

PINE PI - BE4803M3PI

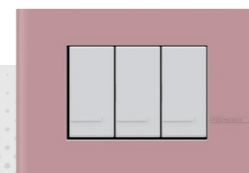

PINK PK - BE4803M3PK

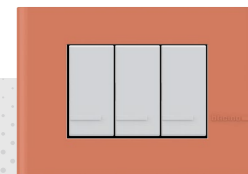

LIGHT AMBER AB - BE4803M3AB

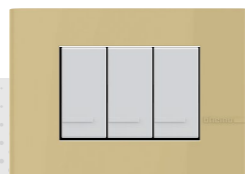

LIGHT YELLOW LY - BE4803M3LY

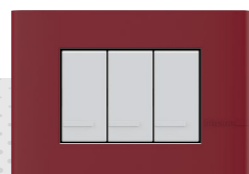

BRIGHT RED RE - BE4803M3RE

METAL EFFECT

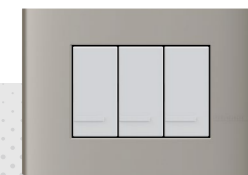

TITANIUM TT - BE4803M3TT

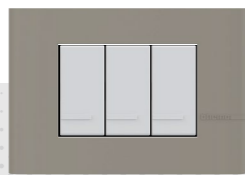

LIGHT BROWN LB - BE4803M3LB

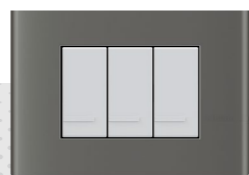

DARK BROWN DB - BE4803M3DB

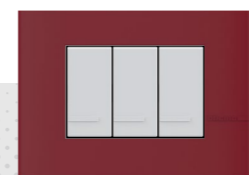

RED RD - BE4803M3RD

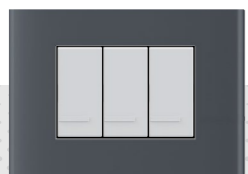

BLUE VIOLET BV - BE4803M3BV

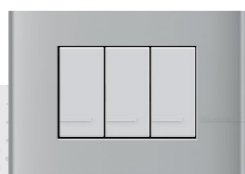

SILVER SL - BE4803M3SL

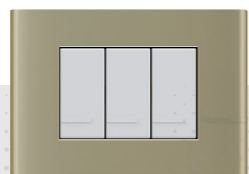

MATT GOLD GL - BE4803M3GL



DURABLE & TIMELESS DESIGN



MAGIC

BASIC CONTROL DEVICES مفاتيح التحكم الاساسيه



ITEM	BASIC CONTROL DEVICES
<input type="checkbox"/> 5001E	1 way switch/ (250V a.c.) - 16A 1P
<input type="checkbox"/> 5003E	2 way switch/(250V a.c.) - 16A 1P
<input type="checkbox"/> 5012E	Intermediate swich . 16 A.
<input type="checkbox"/> 5005E	pushbutton/(250V a.c.) - 16A NO 1P
<input type="checkbox"/> 5011*	switch 2P 16 A 250V a.c.
<input type="checkbox"/> 5052N*	1P 16 A 250V a.c. key 1-0-2 double interlock
<input type="checkbox"/> 5006N*	button 1P NO 10 A 250V a.c. - with 1.8m long cord

* ملحوظة : هذا المنتج متاح عند الطلب

DIMMER ديمر

ITEM	DIMMER
<input type="checkbox"/> 5361*	rotary dimmer for resistive loads - 100W/500W 230 Va.c.

* ملحوظة : هذا المنتج متاح عند الطلب

BELL جرس

ITEM	BELL
<input type="checkbox"/> 5041N	bronze bell - 230va.c. 8 VA.

SOCKETS مخارج الكهرباء



ITEM	SOCKETS
<input type="checkbox"/> 5022E	10/16A 2P - Distance between centers 19 mm - contacts ϕ 4 - 4.8 mm
<input type="checkbox"/> 5180	10/16A 2P+E Distance between centers 19-26 mm - contacts ϕ 4.4 - 5.5 mm protected receptacles.
<input type="checkbox"/> 5440/3	10/16A 2P+E Schuko type + central earth - distance between contacts 19 mm - contacts ϕ 5.6 mm - protected receptacles.
<input type="checkbox"/> 5025	10/16 A 2p - Euro American Standard

TV, TELEPHONE AND INTERNET مخارج التلفزيون، التليفون والإنترنت



ITEM	TV JACKS
<input type="checkbox"/> 5152D	shunted coax jack for single- user antenna systems
<input type="checkbox"/> 5152E	shunted sat socket

ITEM	RJ45 CONNECTORS
<input type="checkbox"/> 5979/5E	RJ45 Cat. 5E - UTP - toolless termination - with shutter
<input type="checkbox"/> 5979C6	RJ45 Cat. 6 - UTP - toolless termination - with shutter

ITEM	RJ11 - RJ12 CONNECTORS
<input type="checkbox"/> 5021M/4	RJ11 - 2 pairs
<input type="checkbox"/> 5021M/6	RJ12 - 3 pairs

ITEM	FLEX OUTLET
<input type="checkbox"/> 5009N	Flex outlet - ϕ 9,5 mm hole

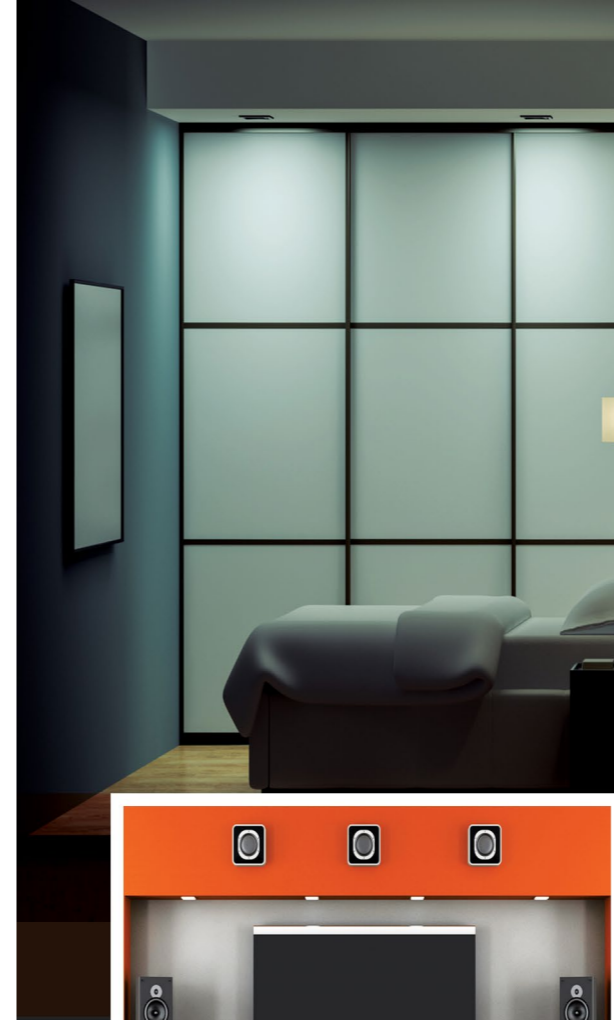

MCB BT DIN

THE BEST PROTECTION SOLUTION



The **new era** of modular circuit breakers

Bticino completely redesigned its range of MCBs BT DIN for protection against overcurrent and differential.

The new MCB BT DIN, characterized by the same power interruption for all calibration range, propose technical solutions and innovative features to ensure the highest level of protection in any situation.

TECHNICAL DATA

THERMAL-MAGNETIC CIRCUIT BREAKERS

- IN = 10 TO 63 A
- 1P, 2P & 3P
- C CURVE
- BREAKING CAPACITY: 4.5 KA, 6 KA AND 10 KA

COMPLIANCE WITH STANDARDS

BT DIN equipments are manufactured in compliance with specific standards:

	IEC Standard
Thermal-magnetic circuit breakers	IEC 60898-1 / IEC60947

MINI FLUSH MOUNTING CONSUMER UNIT

لوحة 1 أو 2 خط

MINI FLUSH MOUNTING CONSUMER UNIT
لوحة لت تركيب عدد 1 أو 2 قاطع أوتوماتيكي حتى 63 أمبير

ITEM	DESCRIPTION
<input type="checkbox"/> E213/2	Mini flush mounted consumer unit 1 pole or 2 poles



E213/2



The **NEW MCB's** features

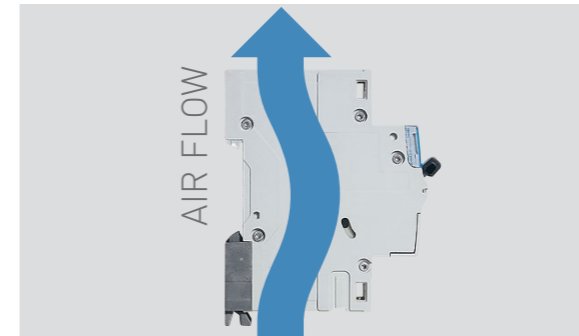

A PRODUCT DESIGNED WITH SAFETY IN MIND

The product design and materials have been carefully developed to allow air to flow freely between each device to avoid overheating.



RISING CAGE CLAMP TERMINALS

For high quality, durable connections.



CLEAR MARKING ON THE FRONT PANEL

For quick visual identification of the relevant information - product name, curve type, rating, breaking capacity, limitation class.



LIMITATION CLASS 3

Circuit breakers with class 3 limitation provide excellent short-circuit protection. They limit the short-circuit energy released in cables and hence help extend the service life of an installation.



WIRE GUIDE FLAP

Avoids connection errors for an increased safety level, by preventing insertion of the wire behind the terminal.

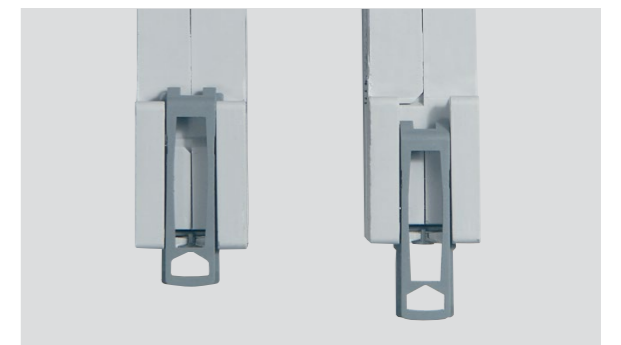

BISTABLE CLIP

For easy positioning or removal of the product on the DIN rail. Compatible with flat-blade or Phillips screwdrivers. Ensures even more comfort during installation.

MCB

MCB BTDIN 4.5K / 6K / 10K

Safety on all levels

قواطع التيار المنمنمة الجديدة
حماية حرارية و مغناطيسية

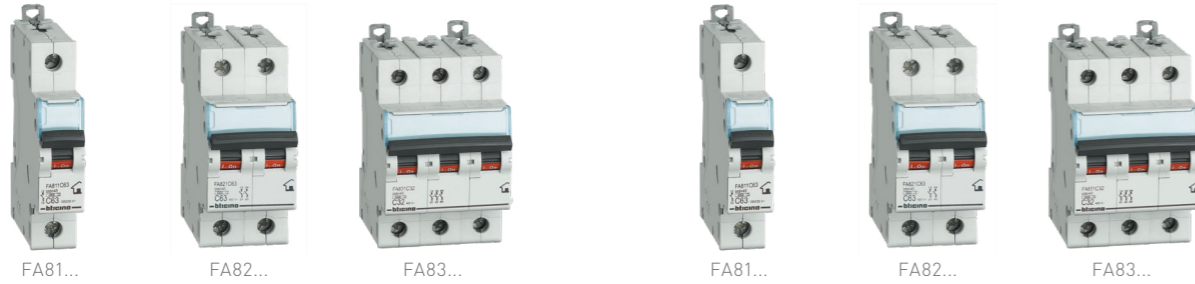

NEW BTDIN45 THERMAL MAGNETIC 4500 A

1-pole - 230/400 Va.c.

CURVA C	IN (A)	N° OF POLES
FA811C10	10	1
FA811C16	16	1
FA811C20	20	1
FA811C25	25	1
FA811C32	32	1
FA811C40	40	1
FA811C50	50	1
FA811C63	63	1

2-poles - 400 Va.c.

CURVA C	IN (A)	N° OF POLES
FA821C10	10	2
FA821C16	16	2
FA821C20	20	2
FA821C25	25	2
FA821C32	32	2
FA821C40	40	2
FA821C50	50	2
FA821C63	63	2

3-poles - 400 Va.c.

CURVA C	IN (A)	N° OF POLES
FA831C10	10	3
FA831C16	16	3
FA831C20	20	3
FA831C25	25	3
FA831C32	32	3
FA831C40	40	3
FA831C50	50	3
FA831C63	63	3

NEW BTDIN60 THERMAL MAGNETIC 6000 A

1-pole - 230/400 Va.c.

CURVA C	IN (A)	N° OF POLES
FH810C10	10	1
FN810C16	16	1
FN810C20	20	1
FN810C25	25	1
FN810C32	32	1
FN810C40	40	1
FN810C50	50	1
FN810C63	63	1

2-poles - 400 Va.c.

CURVA C	IN (A)	N° OF POLES
FN820C10	10	2
FN820C16	16	2
FN820C20	20	2
FN820C25	25	2
FN820C32	32	2
FN820C40	40	2
FN820C50	50	2
FN820C63	63	2

3-poles - 400 Va.c.

CURVA C	IN (A)	N° OF POLES
FN830C10	10	3
FN830C16	16	3
FN830C20	20	3
FN830C25	25	3
FN830C32	32	3
FN830C40	40	3
FN830C50	50	3
FN830C63	63	3

NEW BTDIN10 THERMAL MAGNETIC 10000 A

1-pole - 230/400 Va.c.

CURVA C	IN (A)	N° OF POLES
FH810C10	10	1
FH810C16	16	1
FH810C20	20	1
FH810C25	25	1
FH810C32	32	1
FH810C40	40	1
FH810C50	50	1
FH810C63	63	1

2-poles - 400 Va.c.

CURVA C	IN (A)	N° OF POLES
FH820C10	10	2
FH820C16	16	2
FH820C20	20	2
FH820C25	25	2
FH820C32	32	2
FH820C40	40	2
FH820C50	50	2
FH820C63	63	2

3-poles - 400 Va.c.

CURVA C	IN (A)	N° OF POLES
FH830C10	10	3
FH830C16	16	3
FH830C20	20	3
FH830C25	25	3
FH830C32	32	3
FH830C40	40	3
FH830C50	50	3
FH830C63	63	3



SAFETY BREAKERS

SAFETY WITH A MODERN LOOK

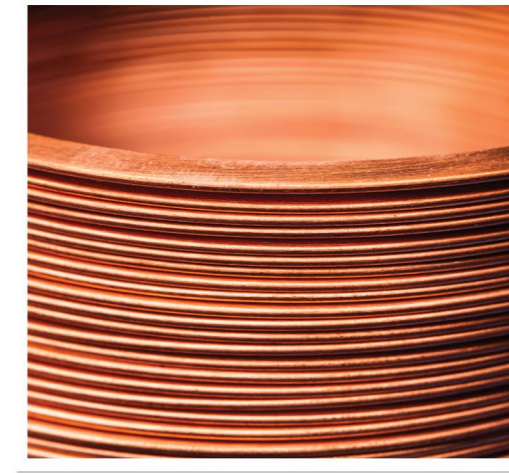

NOTE: AX = filament and fluorescent lamp current □ White colour device

SAFETY BREAKER
PROTECTIVE AND DECORATIVE SOLUTION

مفتاح الحماية
قمة الأمان والشكل العصري

DISCONNECT SWITCH WITH OVER LOAD PROTECTION
مفتاح فصل و حماية من الحمل الزائد



SAFETY BREAKER IN MATIX COVER PLATE

مفتاح حماية فى إطار ماتكس

ITEM	DESCRIPTION
<input type="checkbox"/> BSB1/20EM	Flush mounting safety breaker 2P, For Matix Edge cover plates 20A- 220V~ - 1.5KA
<input type="checkbox"/> BSB1/30EM	Flush mounting safety breaker 2P, For Matix Edge cover plates 30A- 220V~ - 1.5KA
<input type="checkbox"/> BSB1/40EM	Flush mounting safety breaker 2P, For Matix Edge cover plates 40A- 220V~ - 1.5KA

SAFETY BREAKER IN MAGIC ADVANCE COVER PLATE

مفتاح حماية فى إطار ماجيك ادفانس

ITEM	DESCRIPTION
<input type="checkbox"/> BSB1/20EA	Flush mounting safety breaker 2P, Supplied with Magic Advance cover plate 20A- 220V~ - 1.5KA
<input type="checkbox"/> BSB1/30EA	Flush mounting safety breaker 2P, Supplied with Magic Advance cover plate 30A- 220V~ - 1.5KA
<input type="checkbox"/> BSB1/40EA	Flush mounting safety breaker 2P, Supplied with Magic Advance cover plate 40A- 220V~ - 1.5KA

SAFETY BREAKER IN MATIX & SOLIDA COVER PLATE

مفتاح حماية فى إطار ماتكس إيدج و سوليدا



CODES	DESCRIPTION
BSB1/30ESO	Flush mounting safety breaker 1P+N for Solida cover plates, 30A- 230V- 2.5KA (White Cover Plate Included) - New
BSB1/30EMEC	Flush mounting safety breaker 1P+N for Matix Edge cover plates, 30A- 230V- 2.5KA (White Cover Plate Included) - New

SURFACE MOUNTED SAFETY BREAKER

مفتاح حماية خارج الحائط



SAFETY BREAKER IN PLASTIC BACK BOX
مفتاح حماية فى علبة بلاستيك

ITEM	DESCRIPTION
<input type="checkbox"/> BSB1/20ES	Surface mounting safety breaker 20A - 220V~ - 1.5KA
<input type="checkbox"/> BSB1/30ES	Surface mounting safety breaker 30A - 220V~ - 1.5KA
<input type="checkbox"/> BSB1/40ES	Surface mounting safety breaker 40A - 220V~ - 1.5KA

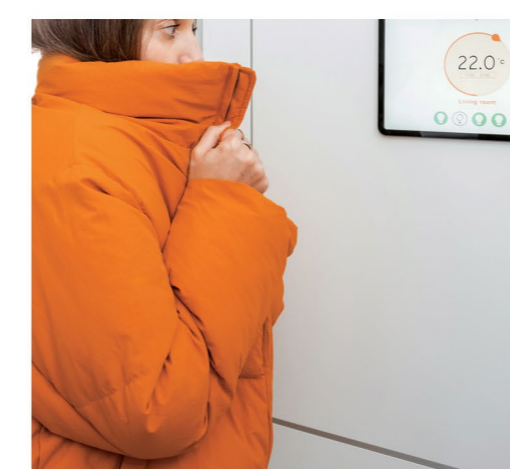

FUSE SWITCH

THE ESSENTIAL POWER SWITCH



FUSE SWITCH

FUSE SWITCH
EXTREME PROTECTION FOR APPLIANCES

مفتاح الفصل والتوصيل
أقصى حماية للأجهزة الكهربائية

SURFACE-MOUNTING FUSED CIRCUIT BREAKERS مفاتيح مجهزة بالمصهرات للتركيب السطحي (خارج الحائط)



ITEM	DESCRIPTION
<input type="checkbox"/> 601	breaker 380V a.c. - with 26A fuses - ceramic body and moulded ivory top - with spare fuse holder
<input type="checkbox"/> 602	single-pole
<input type="checkbox"/> 603	two-pole
<input type="checkbox"/> 603	three-pole

ITEM	DESCRIPTION
<input type="checkbox"/> 602NU	breaker 380V a.c. - with 32A fuses - ceramic body and moulded ivory top - with spare fuse holder
<input type="checkbox"/> 603NU	two-pole
<input type="checkbox"/> 603NU	three-pole

FLUSH-MOUNTING FUSED CIRCUIT BREAKERS

مفاتيح مجهزة بالمصهرات
للتثبيت داخل الحائط



ITEM	DESCRIPTION
<input type="checkbox"/> 642M	breaker 380V a.c. - with 26A and 32A fuses - ceramic body and moulded ivory top - with spare fuse holder
<input type="checkbox"/> 642NUM	26A two-pole
<input type="checkbox"/> 642NUM	32A two-pole

ITEM	DESCRIPTION
<input type="checkbox"/> 643	breaker 380V a.c. - with 26A and 32A fuses - ceramic body and moulded ivory top - with spare fuse holder
<input type="checkbox"/> 643NU	26A three-pole
<input type="checkbox"/> 643NU	32A three-pole

FLUSH-MOUNTING BOX FOR FUSED CIRCUIT BREAKERS

علبة داخل الحائط لتثبيت المفاتيح
المجهزة بالمصهرات



642YB
(121x61x46 mm)

ITEM	DESCRIPTION
<input type="checkbox"/> 642YB	plastic rectangular box for fuse switch

FUSE SWITCH IS COMPLYING
WITH SPECIFIC STANDARDS: IEC Standard

Fuse Switch	IEC 62080
-------------	-----------



COMPLIMENTARY PRODUCTS

NECESSARY SOLUTIONS





EMB Electrical Industries S.A.E.

Headquarter office

Pyramids Heights Office Park
KM 22 Cairo - Alex. desert road
Building 9C, 12556
Tel.: +202 3536 0000
Fax: +202 3536 0001
www.bticino.com.eg

FOLLOW US ON



www.bticino.com.eg



facebook.com/bticinoEgypt



instagram.com/bticinoEgypt

bticino